

# Offshore Wind Energy in the North Sea

Technical Possibilities and Ecological  
Considerations - A Study for Greenpeace

October 2000

Holger Söker  
Dr. Knud Rehfeldt  
Fritz Santjer  
Martin Strack

Deutsches Windenergie-Institut GmbH  
Ebertstr. 96  
D-26382 Wilhelmshaven

Dr. Matthias Schreiber

Schreiber Umweltplanung  
Blankenburgerstr. 34  
D-49565 Bramsche

## Table of Contents

Foreword from Greenpeace.....	5
1. Introduction.....	8
1.1 Development of Wind Energy Use in Europe and Prognosis until 2004.....	8
1.1.1 Example: Prognosis for the Development of Wind Energy in Germany until 2005.....	10
1.2 Role of Wind Energy Use in Climate & Resource Conservation.....	13
1.2.1 Germany.....	13
1.2.2 Belgium.....	14
1.2.3 Denmark.....	14
1.2.4 The Netherlands.....	15
1.2.5 United Kingdom.....	15
1.3 Motivation for Offshore Wind Energy Use.....	16
1.4 National Offshore Programmes.....	17
1.4.1 Denmark's Action Plan for Offshore Wind Farms in Danish Waters.....	17
1.4.2 The Netherlands Implementation Plan for Offshore Wind Energy.....	17
1.4.3 Germany's Renewable Energy Law.....	17
1.4.4 The United Kingdom's Support Mechanisms for Renewable Energy.....	18
1.4.5 Belgian Renewable Energy Law.....	18
1.5 References.....	18
2. Offshore Wind Energy Potential in the North Sea.....	20
2.1 General Offshore Wind Resources in the North Sea.....	20
2.1.1 Measurements.....	20
2.1.2 Estimation from Land Based Wind Speed Data / from Sea Level Pressure Data by Means of the European Wind Atlas Methods.....	20
2.1.3 Other Information.....	21
2.1.4 Conclusion on General Wind Resources in the North Sea.....	22
2.2 Site Specific Wind Resource Assessment.....	22
2.3 Wind Characteristics.....	24
2.3.1 Wind Speed Distribution.....	24
2.3.2 Wind Speed Profile.....	24
2.3.3 Turbulence Characteristics.....	25
2.4 Water Depth and Waves.....	26
2.5 Estimate of the Offshore Wind Energy Potential in the North Sea.....	29
2.6 References.....	29
3. Technology & Economics.....	31
3.1 Offshore Turbine Size.....	31
3.2 Marinised Wind Turbine Design.....	32
3.2.1 Rotor Speed.....	32
3.2.2 Variable Speed Operation.....	32
3.2.3 Number of Rotor Blades.....	32
3.2.4 Machine Design.....	32
Protection against Marine Environment.....	32
Lifting Equipment.....	33
Location of Transformer and other Electrical Gear.....	33
Boat or Helicopter Landing Facilities.....	33
3.2.5 Control System.....	34
3.2.6 Power Supply Unit.....	34
3.3 Marinised Wind Farm Design.....	34
3.4 Support Structures.....	35
3.4.1 Gravity Based Support Structure.....	35
3.4.2 Monopile.....	37
3.4.3 Tripod.....	38
3.4.4 Floating Support Structure.....	40
The Buoy Type.....	40
The Semi-submersible Type.....	41
General Remarks.....	41
3.5 Building, Operation & Maintenance Considerations.....	42
3.5.1 Construction Effort.....	42
3.5.2 Operation & Maintenance Effort.....	42
3.6 Grid Integration.....	43

3.6.1	Transmission from the Wind Farm to the Grid .....	45
3.6.2	High Voltage Three Phase A.C. Transmission.....	46
3.6.3	The Offshore Substation.....	46
3.6.4	Transmission Line Between Offshore Wind Farm and Mainland Grid .....	46
3.6.5	The Onshore Substation.....	47
3.6.6	High Voltage DC Transmission (HVDCT) .....	47
3.6.7	Point of Coupling to the Mainland Grid.....	48
3.6.8	Magnetic Fields .....	48
3.7	References .....	53
4.	Economics .....	55
4.1	Basic Conditions of the Cost Analysis - German Case Study .....	55
4.2	Prognosis of Power Generation Cost - German Case Study.....	57
4.3	Analysis of the Results- German Case Study.....	58
4.4	Summary.....	59
4.5	References.....	60
5.	Environmental Impact Assessment (EIA) .....	61
5.1	Strategic Considerations .....	61
5.2.	Legal Background on EIA .....	61
5.3.	Extent of an EIA .....	62
5.3.1	Possible Environmental Impact During Installation of a Wind farm .....	63
Disturbance of Soil and Sea Bed .....	63	
Disturbance of the Water.....	64	
Disturbance of Benthos .....	64	
Disturbance of Fish.....	64	
Disturbance of Sea Mammals .....	65	
Disturbance of Sea Birds.....	65	
Destroying of Marine Archaeological Sites and Items.....	66	
5.3.2.	Possible Environmental Impact Due to Connecting the Wind Farm to the Grid .....	66
5.3.3.	Possible Environmental Impact by Normal Wind Farm Operation.....	67
Disturbance of Water.....	67	
Disturbance of Sea Bed.....	67	
Contamination of the Environment by Materials.....	68	
Impact by Electric Fields and Heat Generated from the Cable Links .....	68	
Disturbance on Benthos .....	69	
Disturbance of Fish.....	69	
Disturbance of Mammals.....	70	
Disturbance of Birds .....	71	
Collision of Birds with the Turbines .....	71	
Wind Turbines as Barriers .....	72	
Ousting Birds off Their Traditional Feeding or Roosting Grounds .....	73	
Impact on Landscape .....	75	
5.3.4.	Possible Environmental Impact During Dismantling of the Wind Turbines .....	75
5.4	Conclusion and Recommended Practice for EIA.....	76
5.5	References .....	78
6.	Socio-Economic Effects.....	80
6.1	References .....	82
7.	Conclusions .....	83

## Foreword from Greenpeace

For millenia, the North Sea has been a body of water connecting ancient civilisations. It has been a rich source of food for all that time; more recently it has become a rich source of energy. Every year, hundreds of millions of tonnes of fossil fuel are produced from 400 oil and gas platforms. Now the world is aware that the large amounts of the greenhouse gas carbon dioxide released by these fuels is unsustainable. The earth is getting warmer. Melting glaciers, floods and forest fires and more frequent extreme weather events are harbingers of a nearing climate disaster. However, as this report reveals, the North Sea also holds a vast, but unseen, energy supply which is clean, safe and sustainable. If used wisely, nature's answer to climate change is on our doorstep.

To enable offshore wind-power facilities in the whole of the North Sea to be planned and approved in an effective and environmentally friendly way, Greenpeace has, in collaboration with the *Deutsches Windenergie Institut*, devised a way for the requisite environmental impact assessments to be organised. The Institute has compiled information on state-of-the-art technology, the potential for protecting the climate, and the profitability currently attainable.

This report has been commissioned by Greenpeace to allow insight into what off-shore wind resources are ready for exploitation with today's technology and expertise. It has also sought to answer fundamental questions as to how this key sector is developed with minimum harm to the local environment as we fight to save the ecology of the planet as a whole.

**The North Sea** became an industrial area for energy decades ago, with devastating consequences for the marine flora and fauna as drilling mud and oil leaks contaminate the sea bed. The nuclear power industry continues to pollute the North Sea by pumping radioactive waste from reprocessing plants at Sellafield and La Hague that continue to pollute the North Sea. Nuclear energy provides no real solution to the climate problem; there is still no final disposal site for highly radioactive waste, the industry has never proved its safety and the production of plutonium which can be made into weapons leaves its expansion a threat to world peace. Alternatives to both fossil fuels and nuclear power must be found.

**Why offshore wind power?** Wind power is the fastest growing energy technology in the world. It has proven that renewable energy is ready and able to match conventional energy technologies dollar for dollar, kilowatt for kilowatt. The industry has now developed technology of sufficient size, reliability and efficiency that it is ready to unlock the vast off-shore wind resources around the world.

As this report shows, Europe has the technical potential to cover its entire demand for power with offshore wind energy alone. To attain the goals for climate protection agreed in international protocols, wind energy must be developed as a matter of urgency. Wind power already saves Northern Europe about 8.5 million tonnes in CO<sub>2</sub> emissions a year. As the study shows, there could be 21.31 million tonnes of reduction as early as 2005 if off-shore wind is mobilised.

**Why now?** Efforts taken to develop offshore wind farms differ a great deal from country to country in the Europe. Denmark and Germany have by far the most advanced plans; others seem aware but slow to move; while others seem oblivious to this natural powerhouse on their doorstep. This inertia needs to be overcome.

The step to unlock offshore wind energy is particularly subject to political, industrial and sectoral obstacles. There is no standard licensing procedure for off-shore sites in European countries. The grid infrastructure is designed around large conventional fossil and nuclear plants. The access of renewable developments to the grid is still not guaranteed, but subject to the whims of utilities.

**Is Offshore wind power economic?** If offshore wind installations have to carry the burden of the grid extension to new offshore fields, it will be up to 60% more expensive to install than onshore as the costs of foundations and connections to the grid are much greater. However balancing this are the much higher resource yields - shown to be 40% more energy than for

equivalent coastal installations – and the much longer hardware lifetimes due to reduced turbulence. This means relatively high-capacity offshore wind farms in waters near the coast would already be economic within existing European renewable promotion mechanisms. However, if governments accept that the extension of grid to unlock these fields is part of sustainable infrastructure development then grid extension would be absorbed in the transmission costs (as is the case with conventional power facilities on land). This would reduce costs by up to 1/3 and make off-shore wind an aggressively competitive form of energy in Europe.

**How does off shore wind affect the environment?** This report has identified the practices required to ensure environmentally sound off- shore wind development. It notes that the plans, construction and operation of an offshore wind farm must take into account a series of important ecological conditions as well as technical requirements. With ecological and economic considerations making competing claims, dependable conditions must be established for offshore wind-power facilities. This report provides a basis for establishing the environmental conditions that must be met for sound development (with the provision that strategic environmental impact assessment must be undertaken for each specific area before development).

There are substantial differences, internationally and regionally, in the quality of available data in the spheres of ecology, nature protection and patterns of use of the North Sea. Hard and fast statements on a particular area are sometimes impossible to make on account of lack of data. This problem can easily be addressed if the governments of the North Sea countries invest in appropriate research programmes to run in parallel with the opening up of the off-shore wind resource.

**How do we get off shore wind going?** Greenpeace has drawn up a ten- point plan to get offshore wind energy moving in a way that is swift and at the same time environmentally friendly. Off-shore wind energy faces major political and institutional barriers. It will not happen without the political will to clear away the obstacles and assist the off-shore industry in making the transition to sustainable energy.

1. The governments of the North Sea region must halt the issuing of new oil and gas licensing in their territorial or economic exclusion waters and immediately commence licensing sea-bed for development of ecologically sound off-shore wind parks.
2. The governments of the North Sea region must undertake to extend the national grids to the newly licensed fields. Such costs may best be paid for by government infrastructure investment or be absorbed by the electricity transmission operators as part of a transition to a sustainable energy infrastructure.
3. The governments of the North Sea region must undertake to develop programmes or include off-shore wind energy in renewable promotion programmes to encourage investment in and take-up of renewable electricity. Such programs must be assessed on a regular basis for their performance in leveraging investment in the new off shore wind sector.
4. Henceforth all offshore energy installations in the North Sea must be subject to global as well as local Environmental impact assessment that acknowledges the total impact of the activity relative to available alternatives (Strategic EIA) – including the climate benefit or disbenefit.
5. In parallel to the development of the industry, a North Sea biological marine research programme must be undertaken by the governments of the region, aimed at acquiring reliable data that can be used to assist the sound growth of offshore wind parks.
6. In order to accelerate the implementation of new wind capacity in the North Sea, wind measurement programmes must be undertaken by each of the North Sea governments in their waters.

7. The governments of the North Sea region must undertake to collaborate on offshore wind development so as to optimise infrastructure development (including cable laying) and to oversee the cumulative impacts of multiple developments.
8. The governments of the North Sea region must undertake an economic programme of transition to offshore renewable technology for the existing offshore support industries including assistance for the retraining of the offshore workforce.
9. Each government in the North Sea region must make renewable energy and energy efficiency the basis of its greenhouse gas mitigation strategy and reject the use of unproven or low cost loopholes within the Kyoto Protocol.
10. The governments of the North Sea region must undertake to promote renewable technology at a regional level such as the 5<sup>th</sup> North Sea Conference, at a European level and at an international level such as the UNFCCC Kyoto Protocol negotiations.

Greenpeace believes that the 5th North Sea Conference in March 2002 provides an excellent forum to establish an agreement for collaboration and coordination of the transition from fossil fuels to sustainable energy production in the region.

**Offshore wind energy is the obvious transition for the North Sea oil and gas industries.  
Lets get on with it!**

Sven Teske (Greenpeace Germany)  
Karl Mallon (Greenpeace International)  
Bernard Huberlant (Greenpeace Belgium)  
Kathleen McCaughey (Greenpeace Nordic - Sweden)  
Tarjei Haaland (Greenpeace Nordic - Denmark)  
Ian Taylor (Greenpeace United Kingdom)  
Christine Algera (Greenpeace Netherlands)

October, 2000

## 1. Introduction

The debate on the environment and climate protection taking place since the eighties has led to changed energy policies in many industrialized countries. Excessive use of fossil fuels with associated massive output of CO<sub>2</sub> has been recognized as the main driving force in the greenhouse process that causes climate change on a global scale. As a response, many governments have set goals for CO<sub>2</sub> reductions. Whilst looking for solutions in the process of reorganising national energy supply schemes, it has become clear that a sustainable energy economy can only be achieved by mobilising all of the energy saving possibilities together with the intensive use of renewable energy sources.

To arrive at a truly sustainable energy policy all energy sources used in the energy mix must comply with key requirements such as the demand for long term resources, technical and economic availability, environmental integrity and social acceptance. With these requirements in mind it becomes clear that wind energy is an option for the near future. Developments in Europe and the USA over the last decade demonstrate the viability of wind energy use as a true and powerful option when measured against the cited requirements. To underline this statement this study begins with a description of the expected development of wind energy in Europe as well as its implications for the fulfilment of the national climate and resource conservation targets in the North Sea coastal states. On this background the motivations for wind energy industry to move offshore are discussed and some key technical, economic and environmental criteria for offshore wind development are laid out.

### 1.1 Development of Wind Energy Use in Europe and Prognosis until 2004

In the year 1999, the growth rates of wind energy use world-wide and in Europe increased considerably. With a newly installed wind power capacity of 3,924 MW world-wide the installation figures of the previous year were exceeded by 51.0 % [2]. In Europe 3,193 MW of new wind power capacity were installed, which corresponds to an increase of installation figures of 80.8% compared with 1998. This means that the use of wind energy in Europe has increased to a much greater extent than in the rest of the world. Figure 1.1 clearly shows that the growth rates of wind energy use in Europe have surged since 1998, which would suggest that more and more countries are showing an interest in the use of wind energy. This assumption is supported by prognoses of wind energy use up to the year 2004 [1]. According to these prognoses, the power from wind turbines (WT) installed world-wide is expected to increase from 13,934 MW today to 47,514 MW by the year 2004. In Europe, approximately 33,600 MW of installed capacity are expected by 2004. This corresponds to new installations of approx. 23,880 MW within the next five years, which are expected mainly in Germany, Spain, Denmark, Italy, Great Britain and Sweden.

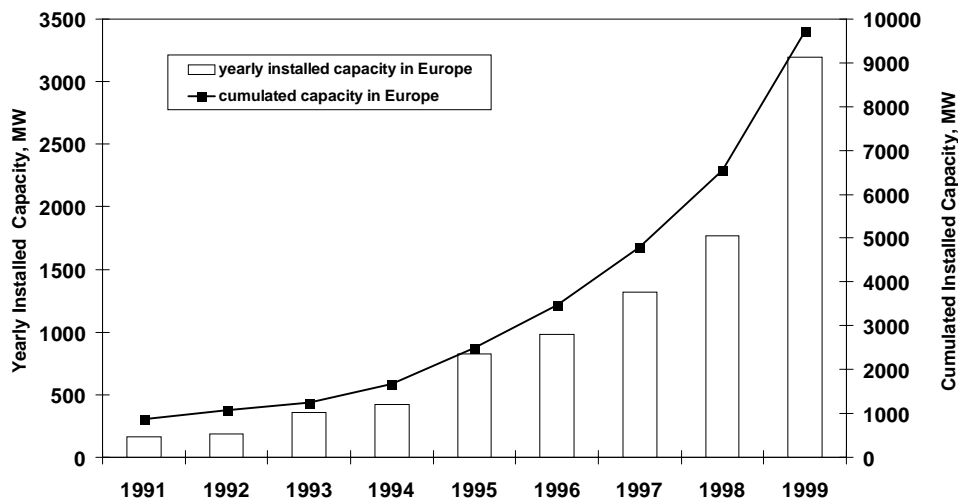

Fig. 1.1: Development of wind energy use in Europe related to the yearly and cumulated installed capacity.

Fig. 1.1 shows the development of wind energy use in Europe. The cumulated installed capacity from wind turbines (WT) in Europe was 9,739 MW at the end of 1999, and 13,934 MW world-wide. Europe therefore continues to be the most important continent for the wind energy industry. In fig. 1.2 the number of newly erected turbines per year as well as the cumulated number of turbines in Europe are presented. In contrast to the curve of the installed capacity, the curve here is less exponential. Because of the increasing size of the new wind turbines installed, the curve shape is much flatter in fig. 2. At the end of 1999 a total of 21,764 WT were installed in Europe; 4,389 of which were erected in 1999.

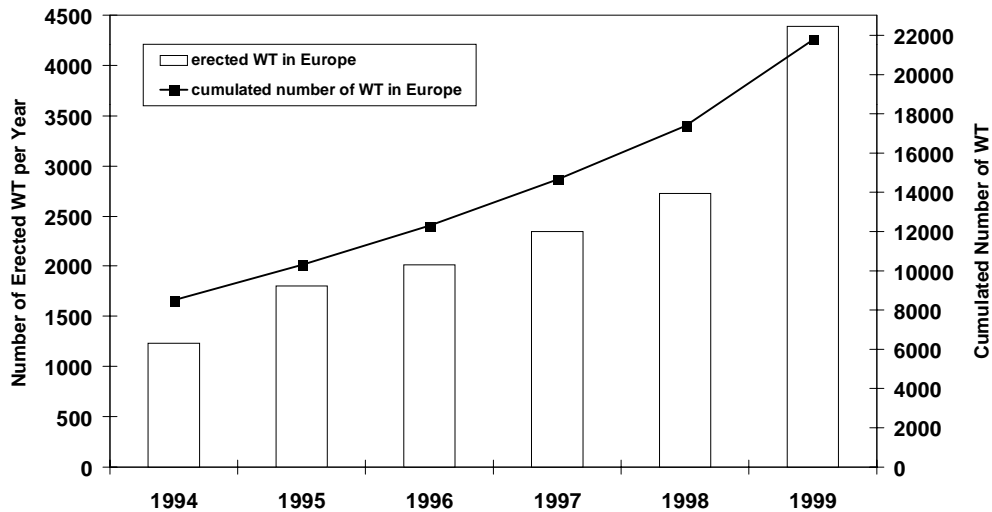

Fig. 1.2: Development of wind energy use in Europe related to the yearly erected and cumulated wind turbines (WT) [1].

	Total Installation End 1999, MW	Installed Power in 1999, MW	Prognosis until 2004, MW
Austria	34	9	214
Belgium	11.2	3.1*	220*
Denmark	1.738	326	3.338
Finland	39	21	244
France	25	4	725
Germany	4.442	1.568	10.540
Greece	158	103	808
Ireland (Rep.)	74	10	329
Italy	277	80	1.477
The Netherlands	433	54	1.208
Norway	13	4	963
Portugal	61	10	261
Spain	1.812	932	9.912
Sweden	220	44	1.145
Switzerland	3	0	123
Turkey	9	0	579
UK	362	24	1.312
Other European countries	27.8	0.9	219
<b>Sum Europe</b>	<b>9.739</b>	<b>3.193</b>	<b>33.617</b>

Tab. 1.1: Wind energy use in Europe (Status 31.12.1999) and prognosis until 2004 [1]  
\* figures for Belgium estimated from section 1.2 Role of Wind Energy  
Conversion in Climate & Resource Conservation

The leading countries in the European market are Germany, Spain and Denmark (see table 1.1). These three countries account for 2,826 MW of the total 3,193 MW installed capacity in 1999. A major growth rate was also achieved in Greece, with a newly installed capacity in 1999 of 103



MW, whereas in the previous year only 28 MW were installed. In the other European countries the development of wind energy use seems dormant. Some countries, such as Norway and Turkey, however, have now been included in the list of wind energy using countries, because more activities are expected in these countries in the near future.

When looking at the prognoses up to the year 2004, it is obvious that in the next five years Europe will be the continent with the highest growth rates in the development of wind energy. In order to fulfil the prognosis of 33,617 MW by the year 2004 capacity 4,775 MW will have to be erected in Europe each year during the next five years. The growth rate in 1999 was 3,193 MW, which indicates that installation figures will have to grow continuously within the next few years. Apart from the excellent prognosis for Germany, which had to be adjusted upwards compared with 1998 [2], a major development of the use of wind energy is expected above all in Spain. In order to achieve the 9,912 MW forecast for Spain by the year 2004, 1,620 MW will have to be installed in Spain each year for the next five years. In Germany, the average amount of newly installed capacity per year is expected to be 1,220 MW for the next five years. The development potential forecast for Denmark of altogether 3,338 MW by 2004 is based mainly on the offshore plans of the Danish government, which intends to install a total of 4,000 MW offshore capacity by 2030. Other European countries that are expected to show an increasing interest in the use of wind energy are Italy, The Netherlands, Sweden and last, but not least, Great Britain. In all of these countries installed wind power capacities of more than 1,000 MW are forecasted by 2004.

#### 1.1.1 Example: Prognosis for the Development of Wind Energy in Germany until 2005

The past six years saw a very rapid development of wind energy use in Germany. The rate of increase related to the new installed capacity per year was more than 50%. In 1999 the rate of increase compared with 1998 was about 100% with a new installed capacity of 1,567MW. The reasons behind such a development were the adoption of the electricity feed-in law, put into force in 1991, and a change of the building construction law in 1996. The electricity feed-in law allowed operators of wind turbines to produce electricity and to sell it to the utilities for a price per kWh which depends on the consumer price of electricity. The changing of the building construction law in 1996 led to a process during which each community defined primary areas for wind energy use. These areas have been used in the last two years and will continue to be used in the near future. At the beginning of 2000 the electricity feed-in law was changed into a fixed price system by the new renewable energy sources act [19]. Privatisation of the electricity market in Germany caused a decrease in the consumer price and a reduction in the reimbursement for electricity from wind energy. The government therefore decided to change the electricity feed-in law into a fixed price system for renewable energy.

The figures of the first half year of 2000 show a positive development for the wind energy use also in the year 2000. With 528 MW installed capacity in the first 6 months of 2000 the situation very much resembles that of 1999. The new installed power for the year 2000 is estimated at 1,600 MW (figure 1.3).

Due to limited space, the development of onshore wind energy in Germany is expected to decrease, thereby affecting overall wind energy use, but only until the development of the offshore sector expands. The underlying assumption is that the first offshore wind farms in Germany will not be built before 2004 or 2005. In figure 1.3 an estimation of the cumulated installed capacity is described. As of 30<sup>th</sup> June 2000 there is a total installed capacity of 4,972 MW. A total capacity of 11,800 MW is expected by 2005.

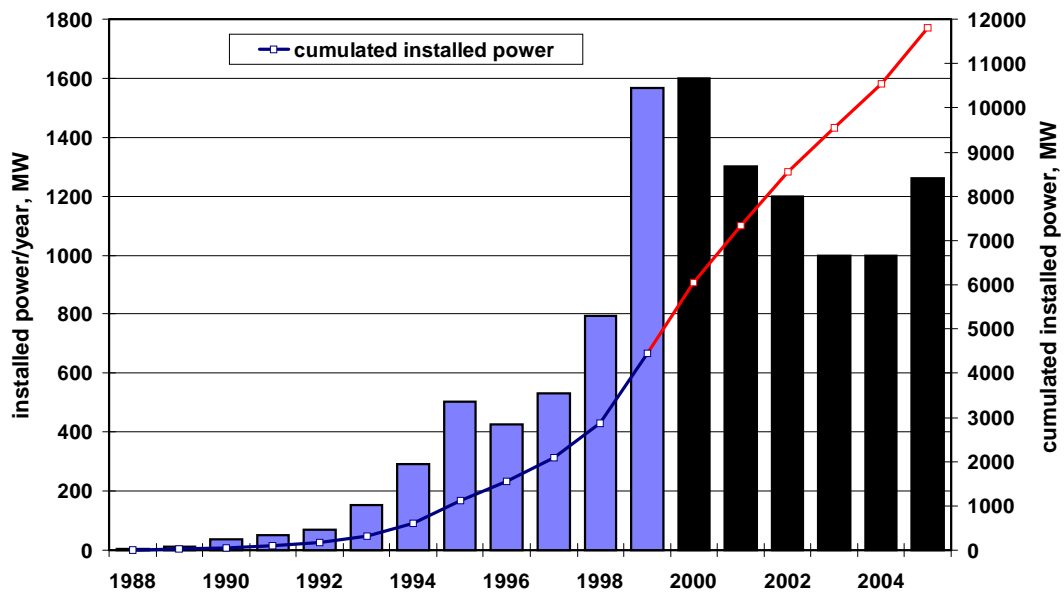

Fig. 1.3: Prognosis of the development of wind energy use in Germany up to the year 2005: columns represent yearly installed power and the curve shows the cumulative installed power.

The rapid development of wind energy use in Germany is accompanied by an increase of the installed power per WT. Figure 1.4 depicts the development of the average installed power per unit. The average value of the first 6 months of the year 2000 is 1,071 kW/unit while WTs with an installed power of 2 MW and 2.5 MW are currently being developed. The prognosis of the average installed power per unit shown in figure 1.4 leads to an average value of 2.15 MW in 2005. The rate of increase in the years 2000 to 2003 is assumed to be at 20 % per year, based on the development since 1997. For the years 2004 and 2005 the rate of increase is estimated at 10 %.

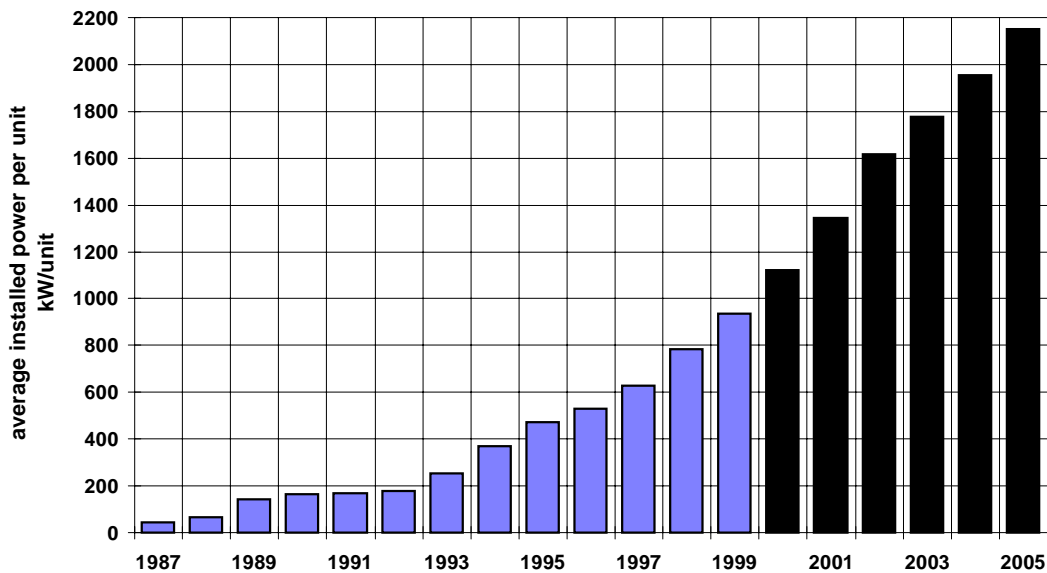

Fig. 1.4: Development of the average installed power per WT and prognosis until 2005.

Based on the prognosis of the new installed power per year (figure 1.3) and the average installed power per WT (figure 1.4) a development of the yearly erected number of turbines has been calculated (figure 1.5).

Due to the strong increase of the average installed power per unit the number of turbines erected yearly in Germany will decrease. For the year 2000, approximately 1,400 WTs will be erected (figure 1.5). This value will decrease to 510 WT in 2004. The trend turns around in 2005

owing to the development of offshore wind farms. The cumulated number of wind turbines is estimated to reach 12,650 WTs in 2005.

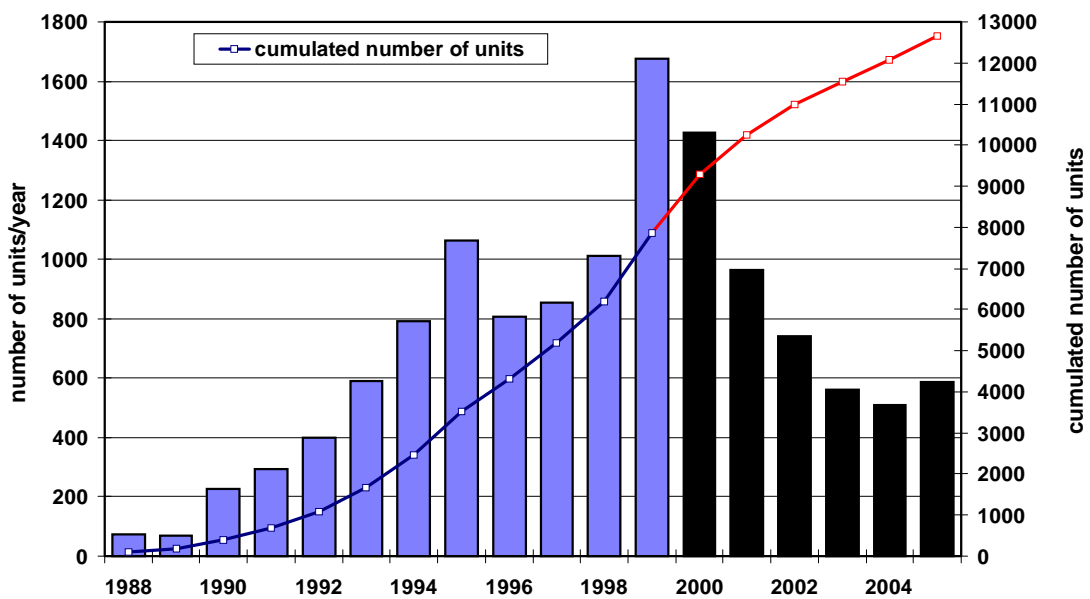

Fig. 1.5: Development of the yearly erected and cumulated number of WT and a prognosis until 2005.

The potential annual energy yield and the share of the potential annual energy yield with respect to the net electrical energy consumption of Germany is shown in figure 1.6. The potential annual energy production with WTs installed by the end of 1999 was 8250 GWh [3]. The share of the potential annual energy production on the net electrical energy consumption is evaluated at 1.7% by the end of 1999.

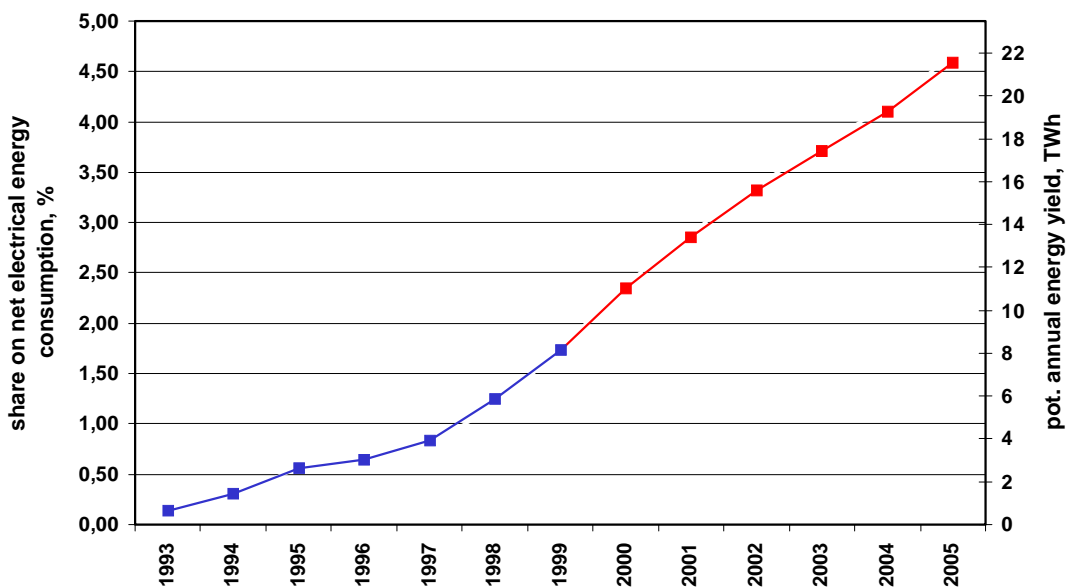

Fig. 1.6: Development and prognosis of the potential annual energy yield of WTs and the share of the net electrical energy consumption in Germany.

Based on the prognosis given above, the potential annual energy yield will increase up to 21,900 GWh in 2005. This value corresponds to a share of net electrical energy consumption in Germany of 4.6 % based on the consumption levels of 1998.

If the development of offshore wind farms will start in Germany in the years 2004 and 2005, a strong increase of the installed capacity can be expected after 2005 because of the large size of offshore wind farms. However such a development will strongly depend on politic support in Germany for renewable energy in general and specifically in favour of offshore wind energy use. If political will does clearly support offshore wind energy development the prognosis for the years 2004 and later will still be substantially short of the real potential.

## 1.2 Role of Wind Energy Use in Climate & Resource Conservation

The role of wind energy use in climate protection and resource conservation is demonstrated on the basis of the development of wind energy as described in the previous section. The potential annual energy outputs that may be obtained with the WTs installed by the end of 1999 are estimated, and the capacity expected by 2005/2004 are taken as the basis for the following findings.

### 1.2.1 Germany

The contribution of wind energy use in Germany (as described in section 1.1.1) to CO<sub>2</sub> reductions depends on the way the fuel savings are calculated. Generally there are two different approaches: one approach takes nuclear power into account whilst the other does not. Nuclear power plants cover the base load and therefore are not designed to change their power output in a short time interval. While wind generated electrical power fluctuates rather quickly with the meteorological patterns and hence will compensate for fossil fuel fired medium load plants in the first place, it makes sense to calculate the possible fuel savings without considering the compensation for nuclear power. However, it is pointed out that in combination with a suitable energy storage technique, such as hydro power or even hydrogen, wind power may also compensate for nuclear power.

In table 1.2 values of the specific CO<sub>2</sub> reduction in kg/kWh are given for different conditions, along with their CO<sub>2</sub> reduction potential in million tonnes, using the annual energy yield of 1999 and the prognosis up to 2005 taken from the previous section.

	Spec. CO <sub>2</sub> reduction	CO <sub>2</sub> reduction - status 31.12.1999	Prognosis up to 2005
Fuel savings corresponding to the mixture of electricity production in 1995 without nuclear power [4]	0.93 kg/kWh	7.67 million t. CO <sub>2</sub>	20.37 million t. CO <sub>2</sub>
Fuel savings corresponding to the actual mixture of electricity production (1995) [4]	0.60 kg/kWh	4.95 million t. CO <sub>2</sub>	13.14 million t. CO <sub>2</sub>
Fuel savings from coal, oil and gas [5]	0.89 kg/kWh	7.34 million t. CO <sub>2</sub>	19.50 million t. CO <sub>2</sub>
Fuel savings from coal, oil, gas and nuclear power [5]	0.58 kg/kWh	4.79 million t. CO <sub>2</sub>	12.71 million t. CO <sub>2</sub>

Tab. 1.2: Achievable CO<sub>2</sub> reductions in the electricity supply sector in Germany on account of wind energy use.

The German government has decided to reduce 25% of Germany's CO<sub>2</sub> emissions based on the figures of the year 1990 by 2005. Based on the Kyoto agreement, Germany must reduce its CO<sub>2</sub> emissions by 21% between 2008 and 2012. However, the climate protection commission of the German Bundestag recommends that Germany reduce its CO<sub>2</sub> emissions by 50% by 2020 and 80% by 2050.

The first aim, the 25% reduction of CO<sub>2</sub> emissions by 2005, will be considered in the following table and is based on the CO<sub>2</sub> emission level of 1990, some 1014 million tonnes of CO<sub>2</sub> for the total energy supply sector. With respect to the 25% reduction of CO<sub>2</sub> emissions, the share of the reduction based on wind energy use by the end of 1999 is between 1.9 and 3.0%. By 2005 this share could grow from 5.0 to 8.0%. However, wind energy use can only contribute to a CO<sub>2</sub> reduction in the electricity supply sector. Therefore the share of wind energy has to be calculated for a 25% reduction of CO<sub>2</sub> emissions induced by the electricity supply sector. Up to 2005 this share could make up some 15.0 to 24.1% (tab. 1.3).

Potential annual energy yield	Share of the 25 % reduction of CO <sub>2</sub> for the energy supply	Share of the 25 % reduction of CO <sub>2</sub> for the electricity supply sector
8251 GWh (31.12.1999)	1.9 %* - 3.0 %**	5.7 %* - 9.1 %**
21,906 GWh (prognosis up to 2005)	5.0 %* - 8.0 %**	15.0 %* - 24.1%**

\* Substitution of coal, oil, gas and nuclear power [5]

\*\* Substitution of coal, oil and gas [4]

Tab. 1.3: Share of the CO<sub>2</sub> reduction based on wind energy use in Germany.

## 1.2.2 Belgium

In Belgium a political strategy is followed corresponding to the Kyoto agreement to reduce greenhouse gases (GHG) by 7.5 % by 2010 relative to 1990 levels. For the period after 2010 the same trend is pursued with the reduction reaching 15 % by 2030.

In the context of the Belgian federal law of April 1999 regulating the opening of electricity markets, power suppliers are obliged to supply at least 3 % of electricity from renewable energy sources to their customers in 2004. Rules for the establishment of offshore wind energy are set up by royal decree.

Compared to the situation of other European countries only minor progress can be seen in the development of wind energy in Belgium. By the end of 1999 the installed capacity of wind turbines amounted to merely 11.2 MW [1]. However, currently two offshore demonstration projects of 100 MW each are planned at 7 - 12 km distances from the shore. It is anticipated that the construction of these projects will not begin before 2002.

Potential annual energy yield	GHG-emission reduction	Share of the 7.5 % reduction of GHG-emission for the energy supply
24.3 GWh (31.12.1999)	7095 tons	0.08 %
478 GWh (installation of 220 MW)	139 000 tons	1.6 %

Tab. 1.4: Share of greenhouse gas reductions based on wind energy use in Belgium.

In Table 1.4 the reduction of greenhouse gases are calculated based on wind energy use in Belgium. The 1990 level of greenhouse gas emissions, which is the baseline of this calculation, was 114.5 million tons [6]. By the end of 1999 the share of the wind energy use toward the aim of 7.5% reduction of greenhouse gases was only 0.08 %. After the installation of the two offshore demonstration projects the share of this target will rise to 1.6 %. In order to reach a share of the reduction aim of 10% using wind energy 1,375 MW has to be installed in Belgium. If experiences with the two offshore demonstration projects turn out to be positive, a capacity of this dimension may easily be installed in the offshore areas of Belgium.

## 1.2.3 Denmark

The Danish government's targets regarding the reduction of CO<sub>2</sub> emissions and the use of renewable energy sources are based on the "Danish Plan of Action – Energy 21" which was released in 1996 [7]. This plan aims to achieve a reduction of 20 % CO<sub>2</sub> emissions in Denmark by 2005 in relation to 1988 levels and 50 % by 2030. Due to available resources it is expected that the major part of these reductions will be covered by biomass and wind energy. Therefore 5,500 MW of installed capacity of wind turbines are intended by 2030 with 4,000 MW in the offshore areas of Denmark. A capacity of 750 MW will be erected in 5 large offshore wind farms between 2001 and 2008. For the period 2000 to 2003, a ceiling has been established for the electricity sector's total CO<sub>2</sub>-emission of 23 million tons in 2000, 22 million tons in 2001, 21

million tons in 2002 and 20 million tons in 2003. The ceiling is to be expressed in CO<sub>2</sub> quotas that will be split among the electricity production companies [8].

Potential annual energy yield	Reduction of CO <sub>2</sub> emissions	Share of the 20 % reduction of CO <sub>2</sub> emission for the energy supply sector by 2005 <sup>1</sup> and 50 % by 2030 <sup>2</sup>
3,800 GWh (31.12.1999)	2.82 million tons	24.7 % <sup>1</sup>
7,310 GWh (forecast of 2004)	5.42 million tons	47.5 % <sup>1</sup>
12,045 GWh (Energy Plan 21, 5500 MW by 2030)	8.93 million tons	31.3 % <sup>2</sup>

Tab. 1.5: Share of CO<sub>2</sub> reductions based on wind energy use in Denmark.

In Tab. 1.5 the reduction of CO<sub>2</sub> emissions is calculated based on wind energy use in Denmark. With an installed wind capacity in Denmark of 1.738 MW by the end of 1999, the current avoidance of CO<sub>2</sub> emissions is 2.82 million tons. The current share of a 20 % reduction of CO<sub>2</sub> emissions related to 1988 levels (57.1 million tons CO<sub>2</sub>) is 24.7% while 3,338 MW of installed capacity from wind turbines in Denmark is forecasted by 2004 [1]. With that capacity it will be possible to avoid emitting 5.42 million tons of CO<sub>2</sub>, which represents a share of 47.5% of the 20 % CO<sub>2</sub> reduction aim. If the *Energy 21 Action Plan of the Danish Government* is to be fulfilled, an installed wind capacity 5,500 MW must be achieved by 2030. This capacity leads to an avoidance of 8.93 million tons of CO<sub>2</sub>, which is a share of 31.3 % of the aim to cut in half Denmark's CO<sub>2</sub> emissions by 2030.

#### 1.2.4 The Netherlands

Based on the Kyoto Protocol, the Netherlands must reduce 6 % of its CO<sub>2</sub> emissions by 2010, based on 1990 levels [9] (174 million tons [9a]). The share of the electricity sector related to total CO<sub>2</sub> emissions was 28 % in 1998. In the Third Energy Memorandum of 1995 the Dutch government laid down its target for renewable energy with a 3% contribution in 2000 and a 10 % contribution in 2020 which includes the installation of 2,750MW of wind power [10]. A total of 1,250 MW will be placed offshore because of the limited onshore sites in the Netherlands. In Tab.1.6 the share of CO<sub>2</sub> reductions based on wind energy use in The Netherlands is calculated. By the end of 1999 the installed capacity of wind power was 433 MW which avoids emissions of 0.55 million tons CO<sub>2</sub>. The share of the CO<sub>2</sub> reduction aim of 10 % related to the 1990 level is currently 3.2 %. By 2004 an installed capacity of wind power of 1,208 MW is estimated which avoids 1.54 million tons CO<sub>2</sub> being emitted. With that capacity of wind power, the share of the Dutch government's CO<sub>2</sub> reduction aim will be 8.9 %. If the planned 2,750 MW wind power is installed by 2020 the share of the CO<sub>2</sub> reductions based on wind energy use will increase to 21.9 %.

Potential annual energy yield	Reduction of CO <sub>2</sub> -emission	Share of the 6 % reduction of CO <sub>2</sub> emissions for the energy supply by 2010
945 GWh (31.12.1999)	0.55 million tons	5.3 %
2,635 GWh (forecast of 2004)	1.54 million tons	14.8 %
5,999 GWh (2750MW by 2020)	3,49 million tons	33.4 %

Tab. 1.6: Shares of CO<sub>2</sub> reductions based on wind energy use in The Netherlands.

#### 1.2.5 United Kingdom

The United Kingdom is aiming to reduce its greenhouse gas emissions by 12.5 % from 1990 levels by 2010 [11]. This target is based on the Kyoto Protocol commitment of 1997. Furthermore, the UK has set a stronger domestic goal: to reduce its CO<sub>2</sub> emissions by 20 % by 2010 related to the 1990 levels (168 million tons CO<sub>2</sub>). In the context of these targets the government has proposed that 5% of UK electricity requirements should be met from renewable

energy sources by the end of 2003, and 10% by 2010, provided that the consumer prices remain at acceptable levels [12]. Wind energy use will contribute to intended expansion of the renewable energy use in the UK with 3,450 MW in 2010. A total of 2,400 MW will be installed onshore and 1,050 MW are planned for offshore sites. The current capacity of wind power in the United Kingdom at the end of 1999 was 277 MW. In 2004 the installed capacity of wind power in UK is estimated at 1,312 MW.

Potential annual energy yield	Reduction of CO <sub>2</sub> emissions	Share of the 20 % reduction of CO <sub>2</sub> emissions for the energy supply by 2010
606 GWh (31.12.1999)	0.32 million tons	0.1 %
2,873 GWh (forecast of 2004)	1.5 million tons	4.5 %
7,555 GWh (3,450 MW by 2010)	3.95 million tons	11.8 %

Tab. 1.7: Shares of CO<sub>2</sub> reductions based on wind energy use in the United Kingdom.

The use of wind energy as a share of the UK government's target to reduce 20 % of CO<sub>2</sub> emissions of the energy supply by 2010 are presented in table 1.7. With the current installed capacity of wind power 0.32 million tons of CO<sub>2</sub> can be avoided, which is a 0.1% share of the reduction aim. The estimated 1,312 MW installed wind power at the end of 2004 enables avoidance of 1.5 million tons of CO<sub>2</sub> with a 4.5 % share of the political aim. If the planned 3,450 MW installed wind power capacity is to be installed by 2010, 3.95 million tons of CO<sub>2</sub> could be avoided. The share of the political aim by 2010 would then be 11.8 %.

### 1.3 Motivation for Offshore Wind Energy Use

Having demonstrated the fair portion of CO<sub>2</sub> reductions that can be achieved by the utilisation of onshore wind energy on the one hand and the difficulty in finding space for additional onshore developments on the other hand makes offshore wind energy a compelling alternative. This applies to all of the North Sea coastal states, although it must be noted that the reasons for shortages of onshore sites differ from one country to another. Obviously the real or anticipated shortage of sites onshore is a first important motivation to go offshore.

The fact that wind speeds offshore are considerably higher as compared to onshore sites gives another important reason for offshore wind energy use. With wind speeds well above 8 m/s at a height of 60m, most of the northern European Seas offshore sites are expected to deliver some 40 % more annual energy output than good coastal onshore sites in Belgium, Denmark, the Netherlands and Germany. However, the cost per installed kW is estimated to increase by some 60% [13] when moving offshore. This, in fact, makes the technical availability of the wind turbines a very important issue. It should be noted that the tremendous increase in annual energy output when moving offshore as indicated for Denmark, the Netherlands and Germany cannot be expected in all European countries: for example in the North of the UK, offshore wind speeds are not necessarily higher than the best onshore sites. Therefore moving offshore is less attractive for wind energy developers in this part of Europe.

A third motivation is to overcome land use and planning conflicts that are encountered when developing onshore wind farms. Placing the wind farms offshore will also reduce a wind farm's impact on the landscape and environment - with the larger distances from shore discussed in this report the wind farms are expected to be invisible most of the time [14].

As a fourth motivation, the search of Europe's wind energy industries for new markets is important. Even if the local (North Sea-) offshore market is limited it will enable manufacturers and developers to gather invaluable experiences and also will serve as a show case of the local industries when in future other offshore markets will be developed.

## 1.4 National Offshore Programmes

In response to the aforesaid opportunities to reduce CO<sub>2</sub> emissions, and owing to the described motivations, each of the five North Sea coastal states discussed herein (Denmark, Germany, the Netherlands, the UK and Belgium) have set up programmes to enhance renewable energy sources in general. In some cases they have set up specific regulations for offshore wind energy developments. The following sections will briefly describe the current situation.

### 1.4.1 Denmark's Action Plan for Offshore Wind Farms in Danish Waters

In the context of its Energy 21 Action plan [7] Denmark has adopted the ambitious goals of reducing CO<sub>2</sub> emissions by 20% by 2005 in relation to 1988 and halving the CO<sub>2</sub> emissions by 2030. In the process of implementing these goals the portion of the total gross energy consumption that renewable energy will cover is to increase to 12-14% in 2005 and 35% in 2030. Due to available resources it is expected that the major part of these reductions will be covered by biomass and wind energy. Wind energy's share is assumed to be in excess of 5500 MW with 4000 MW offshore.

In 1999 the Danish Parliament ratified an electricity reform that will introduce a competition-based green electricity market from 2002. The idea is to leave the system of fixed feed-in tariffs and introduce green certificates that renewable energy producers sell on a national stock exchange to consumers/distributors that have to fulfil annual quota.

The development will start out with a total of approximately 750 MW to be installed in 5 sites, Horns Rev (North Sea), Laeso (Kattegat), Omo Stalgrunde, Gedser and Roodsand (Baltic Sea). Capacities of these first phase developments will be around 120-160 MW each with a minimum distance to shore of approximately 10 - 12 kilometres. Installations are scheduled to be erected from 2001 through to 2008. These offshore wind farms will be operated by the two utilities ELSAM and ELKRAFT that are, by governmental agreement, obliged to develop these sites. After completion of a demonstration phase (construction and 2-3 years of operation), which comprises two farms at Horns Rev and Roodsand, decisions for further developments will be made. It should be noted that these first two offshore wind farms will benefit from a fixed feed-in tariff for the first 10 years of operation. A more detailed description on the status of the implementation of the Danish offshore wind energy programme can be found in [14].

### 1.4.2 The Netherlands Implementation Plan for Offshore Wind Energy

The Netherlands' agenda (Duurzame Energie in Opmars: Ministerie van Economische Zaken, 1997) for reorganising the energy supply indicates an objective of 10% share of renewable energy related to the total energy consumption by 2020 [15]. This includes a total of installed wind power of 2750 MW. Due to spatial limitations onshore it is expected that a portion of 1250 MW will be placed offshore. The evaluation of the progress made in introducing renewable energy sources into the electricity supply has led to the conclusion that additional action is needed to reach the set targets. Additional financial support for the development and application of renewable energy, special arrangements for renewable energy in the Electricity Law and exemption of green electricity from the Eco tax along with an acceleration of the liberalisation of the electricity market have been announced by the Ministry of Economic Affairs [10].

Currently, a demonstration project is being prepared [16]. A wind farm of 100 MW installed capacity will be situated at a distance of 8 to 10 kilometers from shore. Six possible locations were investigated: Egmond, Ijmuiden Oost, Ijmuiden West, Zandvoort Oost, Zandvoort west and Katwijk. All locations have been compared using environmental impact assessments (EIA). The government decided in 1999 to choose Egmond as the location for the planned nearshore wind farm.

### 1.4.3 Germany's Renewable Energy Law

There is no firm governmental planning to develop offshore wind energy in Germany. However, governmental objectives are set to cover 5-6% of the national net electricity consumption with wind-generated electricity by 2010, and to reach a 50% renewable energy share of the national



electricity demand by 2050 [17]. To enable strategic planning, DEWI is presently carrying out a national research project commissioned by the German Ministry of Environmental and Landscape Protection on how wind energy can be further developed on- and off-shore and what this development can contribute to the national goals of CO<sub>2</sub> reduction [18].

Furthermore Germany's Renewable Energy Sources Act (EEG – Erneuerbare Energien Gesetz) [19] continues the reimbursement at a fixed feed-in tariff. The development of wind energy in Germany (and elsewhere i.e. Denmark and Spain) under the umbrella of a fixed feed-in tariff system is seen as a major success and as an appropriate tool to develop a strong market. In the reformed EEG a specially raised tariff is foreseen during the first nine years of operation of an offshore wind farm. This regulation is limited to projects coming online before the end of 2006.

#### 1.4.4 The United Kingdom's Support Mechanisms for Renewable Energy

The UK Government has set a target to obtain 10% of UK electricity from renewable energy sources by 2010 [20]. It has also set an interim target to obtain 5% electricity from renewable energy sources by 2003. The UK has not set any separate targets for wind power or offshore wind power.

UK's former NFFO system, a competitive tendering system, is presently being replaced. Projects competing within a NFFO-tender were given the contracts on least cost basis. In this scheme onshore projects and offshore projects had to compete on equal basis and, in a situation where wind resources onshore are almost as good as offshore, it was very difficult for an offshore project to win a contract [13]. A new support mechanism has been announced for 2000 [12] but is not yet in force. The new scheme doesn't include a specific request for offshore wind energy. Electricity will be traded in a new market that obligates suppliers to have a percentage share of renewables in their energy mix. The new system shall include a tradeable certification system. A Climate Change Levy (CCL) will be introduced for businesses, on non-renewable electricity only. It may turn out as a handicap for future wind energy development that under the competitive regime of the the New Electricity Trading Arrangements (NETA) intermittent electricity supply cannot command such high prices as more predictable forms of generation.

However, using an award under the previous non-fossil fuel levy system and EU support, a consortium led by Amec Border Wind is in the process of installing two offshore wind turbines off the coast of Blythe in North East England. These will be commissioned in autumn 2000. [21]

#### 1.4.5 Belgian Renewable Energy Law

According to [22] the Belgian government has decided in the context of the liberalisation of the European electricity market to oblige power suppliers to supply at least 3% of their electricity from renewable energy sources by 2004, by means of a green certificate mechanism. Offshore wind energy will be eligible for green certificate schemes that will, at least transitionally, work along with a fixed premium system for renewables. Rules for the establishment of offshore wind farms will cover the whole Belgian continental shelf and will organise the licensing of offshore wind sites, and determine the guidelines to assess environmental impacts of offshore wind turbines and associated cable-laying operations.

Currently, two 100MW demonstration projects are planned at 7 to 12 km offshore. The locations under investigation are sand-banks offshore from Knokke and Wenduine. Building operations will not begin before 2002.

### 1.5 References

- [1] BTM Consult: International Wind Energy Development. Ringkøbing, Dänemark März 2000.
- [2] Rehfeldt, Knud: Internationale Entwicklung der Windenergienutzung. DEWI-Magazin Nr. 15 (August 1999) Seite 40-47.
- [3] Rehfeldt, Knud: Wind Energy Use in Germany - Status 31.12.1999. DEWI-Magazin No. 16 (February 2000) S. 19-36.
- [4] Hinsch, Ch; Rehfeldt, K.; Reguse, W.: Die Windenergie in verschiedenen Energiemärkten. DEWI-Magazin Nr. 11 (August 1997) S. 30-38.

- [5] Nitsch, Fishedick, et. al.: Klimaschutz durch Nutzung erneuerbarer Energien. Studie im Auftrag des Bundesministeriums für Umwelt, Naturschutz und Reaktorsicherheit und des Umweltbundesamtes. Berlin 1999.
- [6] Energie Instituut KULeuven: Prospective study of the emissions in Belgium until 2008/2012 of greenhouse gasses included the Kyoto Protocol. Study for the Belgian Federal Ministry of Environment.
- [7]: The Offshore Wind Farm Working Group of the Electricity Companies and the Danish Energy Agency, Elkraft, Wind Power Department, SEAS (Editor): Action Plan for Offshore Wind Farms in Danish Waters. 1. English edition. Haslev, Denmark: 1997.
- [8] Madsen, P.H.(RISOE): National Activities – Denmark. In: IEA R&D Wind Annual Report 1999. International Energy Agency, <http://www.iea.org/techno/...>
- [9] N.N.: Uitvoeringsnota Klimaat Beleid. SDU uitgeverij: Deel I en II. Den Haag, The Netherlands: 1999-2000.
- [9a] ECN: Nationale Energie Verkenningen 1995-2000.
- [10] 't Hooft, J. L. (NOVEM): National Activities – The Netherlands. In: IEA R&D Wind Annual Report 1999. International Energy Agency, <http://www.iea.org/techno/...>
- [11] UK Department of Environment, Transport and the Regions: Climate Change – Draft UK Programme, March 2000.
- [12] Fletcher, Ian (ETSU): National Activities - United Kingdom. In: IEA R&D Wind Annual Report 1999. International Energy Agency, <http://www.iea.org/techno/...>
- [13] Godall, N.: Prospects for Offshore Wind Energy. In: Ente per le Nuove Tecnologie, l'Energia e l'Ambiente ENEA (Rome) (Editor): OWEMES 2000 Proceedings. Rome: ENEA, 2000, p. 321-353.
- [14] Rasmussen, S.L.; Bjelskou, J.; Lemming, J.: Experiences and Results From the Implementation of the Danish Offshore Wind Energy Programme. Paper presented at OWEMES 2000, Siracusa, Sicily, Italy. April 13-15, 2000.
- [15] Bakker, C.; Coelingh, J.P.; Arkesteijn, L.A.G.: Winds of Change- A feasibility Study of 10,000 MW Offshore Wind Energy in the North Sea. Adviesbureau E-Connection BV, Delft. May 1997.
- [16] Haskoning: Milieu effectrapportage Locatiekeuze Demonstratieproject Near Shore Windpark. In opdracht van het Ministerie van Economische Zaken en het Ministerie van Volkshuisvesting, Ruimtelijke Ordening en Milieubeheer, 2000.
- [17] Dürrschmidt, Statement on the Workshop "Weiterer Ausbau der Windenergienutzung im Hinblick auf den Klimaschutz", organised by and held at Deutsches Windenergie-Institut, Wilhelmshaven, 4.-5. April 2000.
- [18] Deutsches Windenergie-Institut.: Weiterer Ausbau der Windenergienutzung im Hinblick auf den Klimaschutz. National Research Project presently carried out at Deutsches Windenergie-Institut, Wilhelmshaven.
- [19] Act on Granting Priority to Renewable Energy Sources ( Renewable Energy Sources Act).
- [20] Information supplied by Greenpeace UK.
- [21] Still, D.; Grainger, W.: The Offshore Wind Farms of Blyth. In: Ente per le Nuove Tecnologie, l'Energia e l'Ambiente ENEA (Rome) (Editor): OWEMES 2000 Proceedings. Rome: ENEA, 2000, p. 299-307.
- [22] Information supplied by Greenpeace Belgium.

## 2. Offshore Wind Energy Potential in the North Sea

The predominant concern when looking at the available offshore wind energy potential is the amount of wind resource found in the area of interest. However, there are a number of other constraints limiting the potential that can actually be developed. The main parameters to consider are the annual average wind speed, water depth and distance to shore along with other constraints such as wave height, condition of the seabed and use functions that may limit availability of the areas of interest such as

- nature and landscape conservation
- military use
- dredging & mining concessions
- dumping of dredging spoils
- fishery
- traffic
- pipelines and cables
- recreation

As a comprehensive investigation of the wind energy potential is far beyond the scope of this study, the presented work focuses on a brief description of the wind resources, wind characteristics and the implications of water depth and waves. The most recent investigation on the use functions of the North Sea has been carried out in a pilot study by Oranjewoud [1]. The matter of constraints on the available area for offshore wind energy has also been discussed in [2] (see also section 2.5 *Estimate of the Offshore Wind Energy Potential in the North Sea*).

### 2.1 General Offshore Wind Resources in the North Sea

In the past, a number of studies have been conducted to estimate the wind resources and the available wind energy potential in the European Seas. An overview of these studies can be found in the recent and comprehensive *Study of Offshore Wind Energy in the EC* by Matthies et.al. published in 1995 [2].

In the attempt to characterise offshore wind resources several approaches may be followed:

#### 2.1.1 Measurements

By far the most accurate method is to perform meteorological measurements at the site of interest itself. This requires that a mast be installed and operated for at least one year. As these measurements require a large expense for operation, long term estimates of the wind speed are established by MCP- (Measure Correlate Predict) methods [6] relating campaign offshore data to long term on shore data. Elsam Project has published first measurement results and operating experiences from their stand alone wind and wave measurement system at Horn's Reef off the Danish coast at Esbjerg [3]. In the UK five wind monitoring masts have been set up around the coasts of England and Wales [4]. Information on the exact locations and the obtained results is not yet available.

#### 2.1.2 Estimation from Land Based Wind Speed Data / from Sea Level Pressure Data by Means of the European Wind Atlas Methods

In the standard procedure of the Wind Atlas Analysis and Application Program (WAsP) Method, [5] long term, land-based, wind speed measurement data are used to estimate the geostrophic winds (i.e. wind at 1500 m height free of surface related physics). From the geostrophic winds the near surface wind speed is calculated using information on the local topological features and roughness of the site in question. Figure 2.1 depicts the European offshore wind speed pattern as derived by this method. While this method is state of the art for onshore site development there is some discussion on the validity of the method for offshore siting. In [2] application of the method led to inconsistencies in open sea wind speed estimates depending on the reference measurement station used. More recent research uses long term sea level air pressure data to estimate geostrophic winds over open seas [11].

As a general conclusion from the scientific discussion it might be stated that specific corrections

for coastal and far offshore climates are necessary to account for offshore specific physics - see also section 2.2 *Site Specific Wind Resource Assessment*.

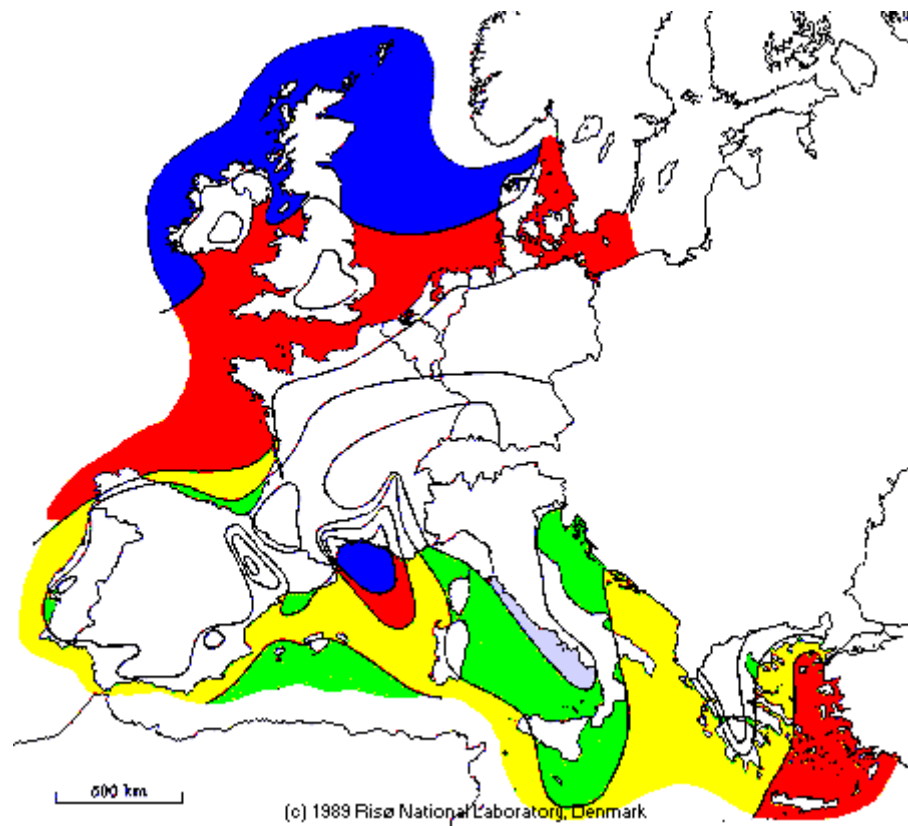

	10 m		25 m		50 m		100 m		200 m	
	m/s	W/m <sup>2</sup>	m/s	W/m <sup>2</sup>	m/s	W/m <sup>2</sup>	m/s	W/m <sup>2</sup>	m/s	W/m <sup>2</sup>
■	> 8.0	> 600	> 8.5	> 700	> 9.0	> 800	> 10.0	> 1100	> 11.0	> 1500
■	7.0-8.0	350-600	7.5-8.5	450-700	8.0-9.0	600-800	8.5-10.0	650-1100	9.5-11.0	900-1500
■	6.0-7.0	250-300	6.5-7.5	300-450	7.0-8.0	400-600	7.5-8.5	450-650	8.0-9.5	600-900
■	4.5-6.0	100-250	5.0-6.5	150-300	5.5-7.0	200-400	6.0-7.5	250-450	6.5-8.0	300-600
■	< 4.5	< 100	< 5.0	< 150	< 5.5	< 200	< 6.0	< 250	< 6.5	< 300

Fig. 2.1: Wind resources over open sea (more than 10 km offshore) for five standard heights [Source: RISØ, <http://130.226.52.108/oceanmap.htm>].

### 2.1.3 Other Information

As there are only very few physical measurements of offshore wind speeds and wave heights, the approach chosen by Matthies et al. [2] was to have a large volume of observations from the Voluntary Observer Fleet (VOF) data base evaluated. The VOF is a fleet of commercial vessels that report their meteorological observations in regular time intervals (every three hours). The methodology of the VOF members uses coded observations of the meteorological and sea state parameters such as wind speed and direction, height and period of the waves. As the wind measurements on moving ships are inconsistent in terms of quality of the measurements the wind speed information has been derived from the sea state parameters. This ensures a consistent methodology and quality of observations throughout the whole of the covered seas. For the North Sea, annual wind speed estimates have been derived for 12 locations along the coast, each using several thousand observations (see figure 2.2). In order to model the transition effects in the coastal zone WAsP methods have been applied. It is important to understand that the described method merely gives a rather rough estimate of the wind resources.

**NOTE:** The figure 2.2 shows annual mean wind speeds at a height of **25m** obtained from VOF data. In order to roughly translate the wind speeds to a height of 60m see the table in figure 2.1. For example, a wind speed of 8.4 m/s in figure 2.2 translates to roughly 9 m/s at 60m height.

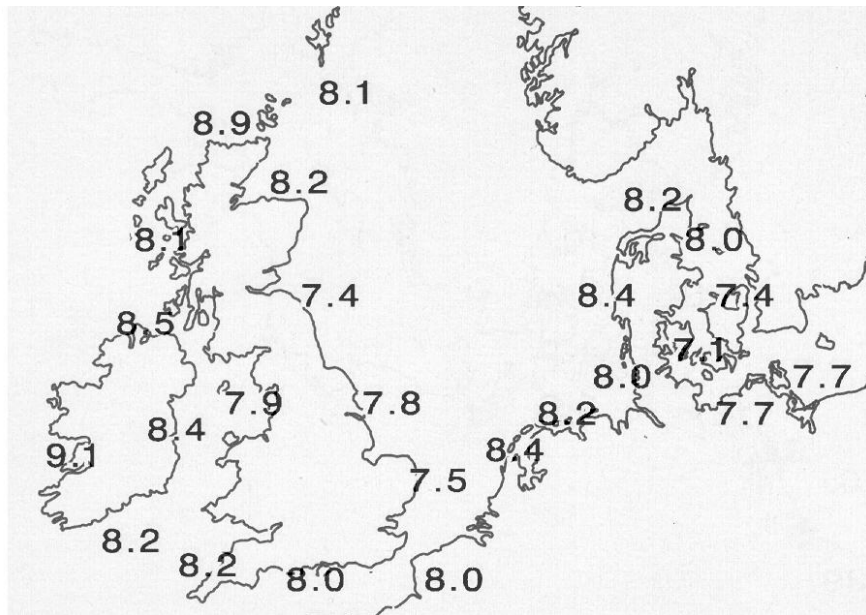

Fig. 2.2: Annual mean wind speeds at 25 m in the North Sea according to VOF data [2].

#### 2.1.4 Conclusion on General Wind Resources in the North Sea

It can be concluded therefore that annual mean wind speeds over the whole of the North Sea can be expected to be in excess of 8 m/s in 60 m height (8 to 9 m/s in the southern part and 9 to 10 m/s in the northern part). These figures however describe the wind speed resources in a rather rough way. Bearing in mind that economic viability of individual wind farm projects is very sensitive to changes in annual wind speed by even a few tenth of m/s the importance of accurate site specific wind resource assessment techniques becomes obvious. The following section is therefore dedicated to give an impression of the difficulties in site-specific wind resource assessment.

### 2.2 Site Specific Wind Resource Assessment

As for onshore sites, site-specific offshore wind potential assessment requires reliable meteorological input data. The commonly used input data for wind potential assessments consists of measured surface wind data, like those from a measuring mast or meteorological stations. Recently, the pressure distribution at large heights have also been used. This data is obtainable based on predictions and reanalysis data from the national weather services. To decrease the influence of inter-annual wind variations, any input data should cover a period of at least 10 years.

The most accurate method is the installation of a meteorological offshore mast at the proposed site for a limited campaign of at least a year. Due to the large expense for operations, long term data acquisition by means of an offshore measurement mast will most probably be restricted to very few sites. Hence for the general situation the measured data from a limited campaign will have to be extrapolated to a long term period using the MCP (Measure-Correlate-Predict) method [6] in combination with data from a reference mast which might even be located onshore. The application of MCP methods for an offshore site in the Baltic Sea has lead to good results [7]. Admittedly, the distance between the offshore and reference mast was quite small (about 10 km). The evaluation of long-term data measured in the North Sea up to 180 km north of the Dutch coast shows distinct differences in the seasonal wind variations, but also shows a good correspondence of the inter-annual wind variations [8]. This implies that for these stations the MCP method can be expected to work well, provided the offshore data cover a period of at

least one full year. The reliability and limitations of different MCP methods for application on lightship wind data from the Northern Sea are currently being investigated by DEWI.

In case the measurement height is not identical with the hub height of the planned wind turbines, an appropriate method for vertical extrapolation of wind conditions is required. The European Wind Atlas Methods, WAsP [5] seems to be suitable for this, even though some effects are not considered by WAsP, i.e. the dependence of surface roughness on wind speed. The accuracy seems to be acceptable, if the thermal conditions in the atmosphere (atmospheric stability) are taken into account [7]. This means that those WAsP parameters describing the atmospheric heat flux have to be adjusted properly, using temperature profile measurements or appropriate literature values.

In situations where the measurement is not located directly at the proposed wind farm site and the measurement site and/or the planned wind farm site are influenced by coastal effects, the application of the WAsP methods can be expected to carry rather large uncertainties. This is due to the discontinuity of the surface roughness and thermal conditions at the coastline, which will generate an internal boundary layer (IBL) and a transition of stability. WAsP is able to calculate these effects to a certain degree, but the transition of stability and the dependence of the IBL on stability in particular are not handled properly. It is known that land effects may spread out up to 50 km to open sea in stable conditions [9], while WAsP practically calculates no land influences for locations more than 30 km offshore. Currently an enhanced model for calculating this coastal transition zone, the Coastal Discontinuity Model (CDM) [10], is being developed at the Risø National Laboratory, in Denmark, and tested against measuring data [8]. The CDM is based on similar principles to WAsP, but performs a time dependent calculation taking into account stability transition. It is designed for use in combination with the WAsP methodology.

The second source for the meteorological input data mentioned above typically consists of a grid of 6-hourly pressure data calculated in the frame of weather prediction on the base of extensive observation data. After performing an interpolation to a finer grid ( $0.5 \approx 30 \times 60 \text{ km}^2$ ), the geostrophic wind, i.e. the (theoretical) wind at heights of about 500 - 1000 m, is derived, using some correlations which are quite simple due to some simple physical attributes at these heights [11]. Applying this procedure on all observations of a long-term period leads to a geostrophic wind distribution for each grid point. This information may then serve as input for the WAsP model to calculate the corresponding surface wind distribution.

The use of pressure data instead of wind speed data as input offers some advantages, especially the fact that this quantity is easier to measure and measurements are by far more difficult to disturb than measurements of wind speed. There are much more data available on pressure observation than wind speed data, including historical long term data. Furthermore, this method has the potential to create a map of the spatial distribution of wind conditions which is consistent for large areas (e.g. the whole of Europe). One principal disadvantage of using WAsP this way is that it requires accurate WAsP-calculated correlations between the geostrophic wind and surface wind. This precondition is not trivial since these correlations are applied in two directions such that errors will cancel each other. However, this procedure needs verification or calibration with surface wind data.

The described procedure is, along with the CDM, part of a currently developed methodology for offshore prediction called "POWER" [10]. Development and testing of these methods is scheduled to be finished in July 2001.

Since a site-specific offshore wind potential assessment will certainly contain a calculation of the park's efficiency, this aspect should be mentioned here, too. The special offshore condition of low turbulence decreases the decay of the shading effects (wakes), that an upwind turbine creates on the inflow to the next downwind machine. Together with the assumption that modern offshore wind farms will be very large in scale, it can be concluded that the park efficiency - and hence the uncertainty of the park efficiency - become more relevant. So the commonly used park models should be investigated and verified in regard to wake decay and wake superimposition.

## 2.3 Wind Characteristics

A description of the wind resources would be incomplete without a brief discussion of offshore wind characteristics. In general, annual average offshore wind speeds are considerably greater than on the coast. Studies indicate increases of about 25% from coastal onshore sites to sites some 10 km offshore. Due to the reduced roughness of the water surface, the turbulence intensity of the wind flow, which is a design driver with respect to wind turbine fatigue, is much lower. Also the wind speed profile is less pronounced i.e. the increase of wind speeds with height is reduced as compared to onshore characteristics.

### 2.3.1 Wind Speed Distribution

Wind speed distribution is commonly modelled by a Weibull distribution. A Weibull shape parameter of approximately 2 (1.93 – 2.11) for the North Sea coastal waters as estimated from VOF data (see section 2.1.1) correlates with the value 2.2 measured for example at Horn's Reef [3].

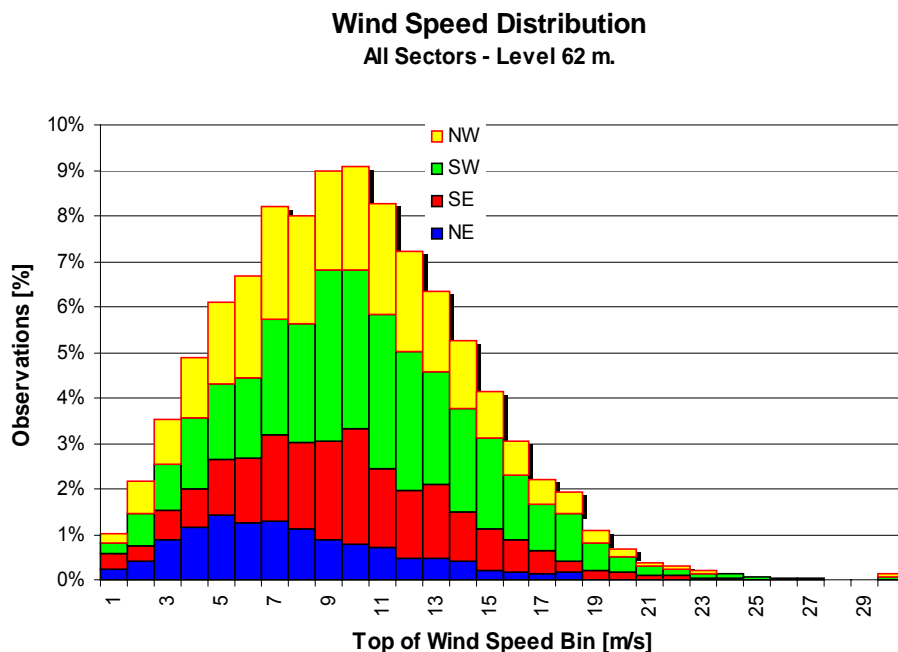

Fig: 2.3: Wind speed distribution at 62m height observed at Horn's Reef [3].

### 2.3.2 Wind Speed Profile

Knowledge of wind speed profile is vital when wind speed measurements are to be extrapolated to heights other than the measurement height. This is commonly done when applying measured wind speed distributions to the various hub heights of turbines. A simple model of how wind speeds increase with height above the surface is given by the logarithmic wind speed profile. In this model, surface roughness is the main parameter determining the shape of the profile and thus the rate of wind speed increases. With greater surface roughness in the onshore case the initial wind speed increase near the surface is rather small but stays on for larger heights giving rise to a stronger wind speed increase at typical wind turbine heights. As surface roughness offshore (referring rather to wavelets and ripples on the water surface than to wave height) is much smaller than onshore, wind speed increases very rapidly starting from the surface. At heights of interest for wind energy use, the gradient becomes rather small. Thus increasing the wind turbines' hub heights above sea level will not lead to increased energy production to the same extent as it does onshore.

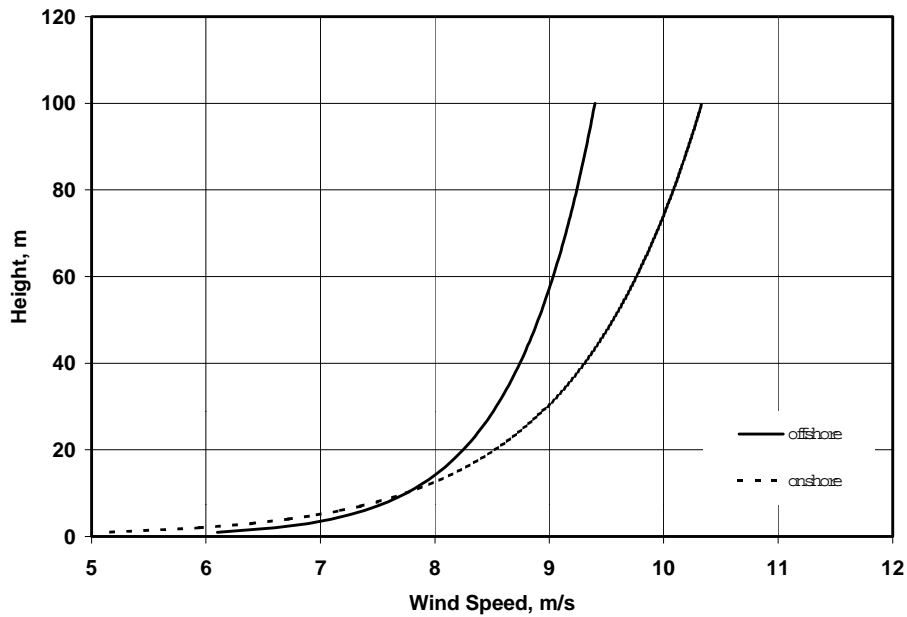

Fig: 2.4: Logarithmic wind speed profiles onshore and offshore. Note: Wind speeds are arbitrarily chosen to coincide at a height of 10m to demonstrate the shape of the profiles. Of course wind speeds onshore are considerably less compared to offshore.

For the offshore situation it has been commonly expected that wind speeds increase with height above sea level according to a logarithmic profile assuming neutral atmospheric stability conditions. Danish measurements, however, show that the prediction by means of the logarithmic profile underestimates the wind speed increase and that the shape of the profile is distorted [7]. Reasons for this are presumably given by atmospheric stability conditions being slightly non neutral on an annual scale. Another reason is seen in the presence of internal boundary layers (see section 2.2).

### 2.3.3 Turbulence Characteristics

The turbulence intensity describes the variation of the momentary wind speed around its average value. It is expressed as the ration of the wind speed standard deviation divided by the corresponding average for a given time interval – usually 10 minutes. The turbulence characteristics of the undisturbed inflow to a wind turbine have a large effect on the severity of the wind turbine's fatigue loading. Furthermore, it is important to realise that with reduced ambient turbulence (offshore) the increase in turbulence experienced by a wind turbine in a wind farm due to a wake created by an upstream operating wind turbine is higher and persists longer downstream than in high ambient turbulence conditions (onshore). In other words: wind farm effects will be more pronounced in offshore situations [12].

Typical values found onshore are well above 10%, while offshore conditions are characterised by values around 8% [12]. Turbulence intensities are found to first decrease with wind speed and then increase again in response to increasing wave heights. Figure 2.4 shows the dependency of turbulence intensity on wind speed as found at Horn's Reef [3].



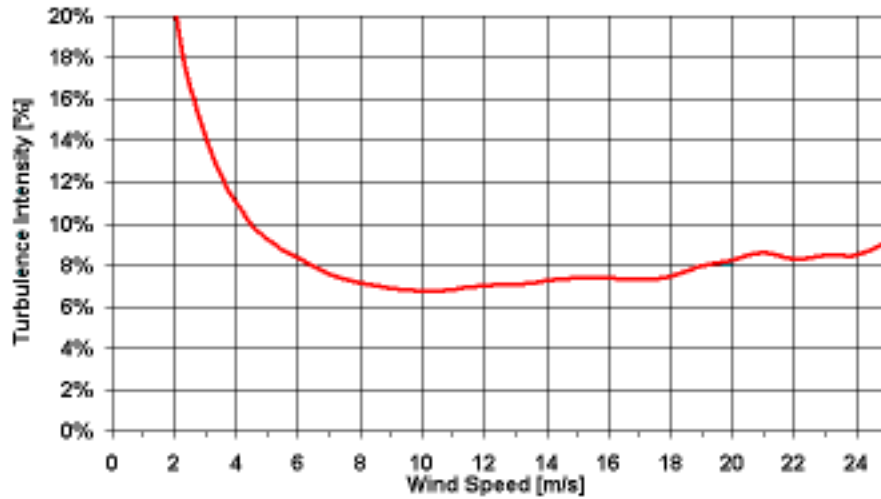

Fig: 2.5: Turbulence Intensity at 62m height observed at Horn's Reef [3].

Beside the dependency on wind speed, turbulence intensity is seen to decrease almost linearly with height as observations at Horn's Reef and other [13] show:

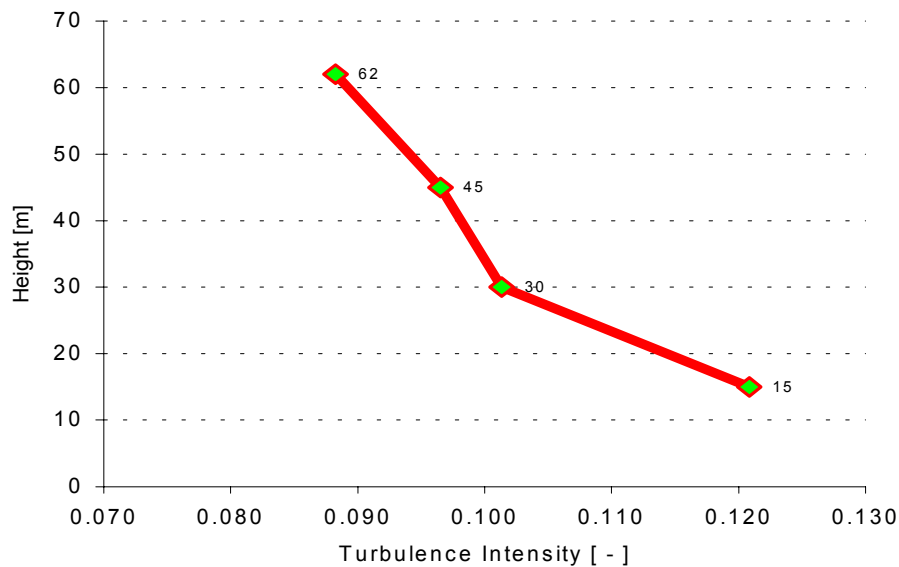

Fig. 2.6: Turbulence Profile at Horn's Reef [3].

## 2.4 Water Depth and Waves

Water depth, another important natural constraint parameter on available offshore wind energy potential, has paramount influence on the design solution and cost of sea bottom based foundations for offshore wind turbines (see Figure 4.1 in section 4 Economics). Not only the pure size and mass of the support structures not only increase with water depth but with also wave loading. Wave heights increase with deeper water and at the same time the longer lever from the waterline where the wave impact takes place down to the sea bed yields a larger turning moment that the support structure has to withstand.

Large parts of the North Sea have rather moderate water depths of up to 50 m. In [1] the areas along the North Sea coast with water depths of less than 50 m are identified. In the German Bight even with distances to shore of up to 70 km water depths do not exceed 40 m (see Figure

4.1 in section 4 Economics) whereas along the UK east coast water depth increases more rapidly. Figure 2.7 gives a more general overview of water depths in the region.

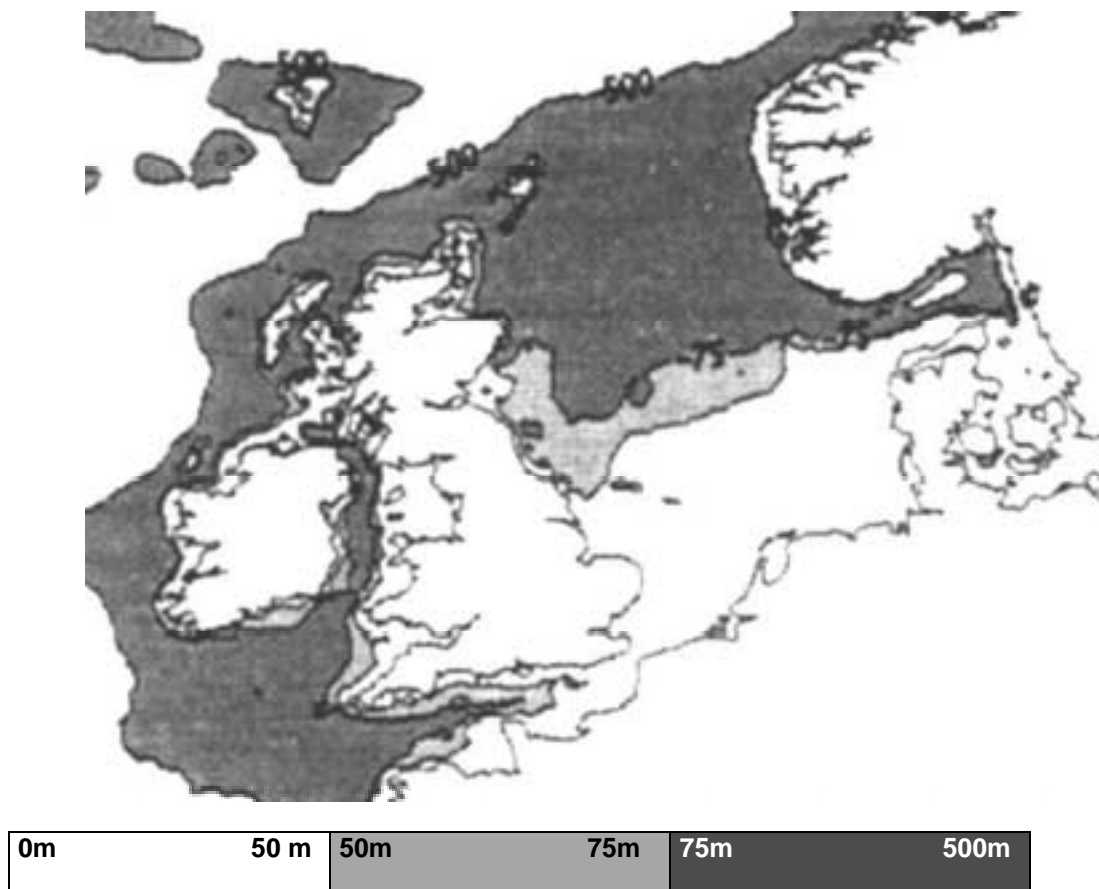

Fig. 2.7: North Sea water depths (source: National Geophysical Data Centre NOAA).

As stated above, wave heights vary with wind speed and with water depth. From the most recent measurements at Horn's Reef the principles can be demonstrated [3]: the observed wave heights increase with wind speed in a more or less linear manner (see figure 2.7). For wind speeds exceeding 20 m/s wave heights seem to reach an upper limit of some 4 m. It is assumed that this is due to shallow water depth causing the waves to break. Adopting this assumption it can be concluded that extreme wave heights are limited by the water depth rather than by wind speed. Extreme wave heights with a frequency of recurrence of 50 years have been evaluated to vary between 6 and 11 m throughout the North Sea [2] (figure 2.8).



## 2.5 Estimate of the Offshore Wind Energy Potential in the North Sea

An estimate of the potential available in the North Sea is taken from the *Study of Offshore Wind Energy in the EC* [2]. The following table gives the figures for the offshore potential for the North Sea coastal states as estimated by the afore-mentioned study. It is important to note that an installed capacity of 6 MW per km<sup>2</sup> was assumed and the following constraints were applied:

- Maximum water depth of 40 m
- Maximum distance to shore of 30 km
- Sea bed slope not exceeding 5°
- Traffic zones are excluded
- Pipelines and cables, with a 2 km exclusion corridor, are excluded
- Oil platforms with a 10 km circular buffer area are excluded
- Conservation areas ( Wadden Sea National Park, only) are excluded

	<b>Max. offshore potential</b> TWh/a	<b>Annual consumption</b> TWh/a	<b>Rel. contribution to national consumption</b> %
UK	986	321	307
Belgium	24	63.2	38
Netherlands	136	75.5	180
Germany	237	431.5	55
Denmark	550	32.2	1708

Table 2.1 Offshore Potential relative to national electricity consumption.

As can be seen from this table, a considerable amount of energy could be gained from offshore wind energy. However, the absolute figures are to be interpreted with prudence, it is possible that not all of the applicable constraints are included by the authors of the study [2] or the constraints may have changed since the study was completed.

## 2.6 References

- [1] Belle, J.v.; Lieshout, S.; Akkeren, S.v.: Offshore Wind Farm Locations in the North Sea. Pilotstudy commissioned by Greenpeace Netherlands, Heerenveen, The Netherlands, 2000. – Not yet published.
- [2] Matthies, H.G. et. al.: Study of Offshore Wind Energy in the EC. Final Report of Joule I contract JOUR-0072 commissioned by the Commission of the European Communities CEC, Verlag Natürliche Energien, Brekendorf, Germany, 1995.
- [3] Neckelmann, S.; Petersen, J.: Evaluation of the stand alone wind and wave measurement system for the Horn's Reef 150MW offshore wind farm in Denmark. In: Ente per le Nuove Tecnologie, l'Energia e l'Ambiente ENEA (Rome) (Editor): OWEMES 2000 Proceedings. Rome: ENEA, 2000, p. 17-27.
- [4] Fletcher, Ian (ETSU): National Activities - United Kingdom. In: IEA R&D Wind Annual Report 1999. International Energy Agency, [http://www.iea.org/techno/...](http://www.iea.org/techno/)
- [5] Mortensen, N.G.; Landberg, L.; Troen, I.; Petersen, E.L.: Wind Analysis and Application Program (WASP). RISØ-I-666(EN). Roskilde (Denmark): RISØ National Laboratory, 1993.
- [6] Gerdes, G.; Strack, M.: Long-term Correlation of Wind Measurement Data. In: DEWI-Magazin (1999), Nr. 15, p. 18-24.
- [7] R.J. Barthelmie: Measurements and Modelling of Coastal Meteorology. In: Ente per le Nuove Tecnologie, l'Energia e l'Ambiente ENEA (Rome) (Editor): OWEMES 2000 Proceedings. Rome: ENEA, 2000, p. 45-59.

- [8] J.P. Coelingh, L. Folkerts, G.F.M. Wiegerinck, E.J. v. Zuylen: Study of the Offshore Wind Climate using a Sodar. In: Ente per le Nuove Tecnologie, l'Energia e l'Ambiente ENEA (Rome) (Editor): OWEMES 2000 Proceedings. Rome: ENEA, 2000, p. 61-71
- [9] G.M. Watson, J.A. Halliday et.al.: Power – A Methodology for Predicting Offshore Wind Energy Resources. In: Ente per le Nuove Tecnologie, l'Energia e l'Ambiente ENEA (Rome) (Editor): OWEMES 2000 Proceedings. Rome: ENEA, 2000, p. 109-120
- [10] R.J. Barthelmie: Developing a Coastal Discontinuity Model for the POWER Project. In: Proceedings of the 1999 Twenty First BWEA Wind Energy Conference, Cambridge, 1999.
- [11] J. Palutikof, T. Holt: Synoptic-Scale Wind Data suitable for the preliminary Assessment of the Off-Shore Wind Resource. In: Ente per le Nuove Tecnologie, l'Energia e l'Ambiente ENEA (Rome) (Editor): OWEMES 2000 Proceedings. Rome: ENEA, 2000, p. 93-107
- [12] Ferguson, M.C. (Editor): OPTI-OWECS. Volume 4 : A Typical Design Solution for an Offshore Wind Energy Conversion System. Final Report on Joule III contract JOR3-CT95-0087 for the Commission of the European Communities, Delft, The Netherlands: Institute for Windenergy, Delft University of Technology, 1998 (IW-98143R).
- [13] R.J. Barthelmie et.al.: Offshore Wind Resources at Danish Measurement Sites. In: European Wind Energy Association (Editor): European Wind Energy Conference 1999 Proceedings. London: (James & James (Science Publishers) Ltd, 1999, p. 1101-1104.

### 3. Technology & Economics

#### 3.1 Offshore Turbine Size

Cutting the extra costs associated with the move offshore has been the major challenge in the development of offshore wind energy technology. Undersea cabling and special foundations are among the main drivers for offshore plant investment cost, showing significant sensitivity to water depth and distance to shore (see [1] and section 4. Economics) but little sensitivity to turbine size. Since the cost for laying undersea cable are governed by the length of the cable rather than its capacity, it is reasonable to assume that a smaller number of units in a wind farm of a given capacity will have a lower cost compared to a development of the same size but composed of a larger number of smaller units. Also when adopting the statement that wave and ice loads are the parameters that determine the required strength and weight of a foundation to a much larger extent than the turbine size itself [1,15,16], using larger units per foundation appears to be more economic. Together with the achievements of onshore wind energy technology the preceding reasoning calls for multi-megawatt machines in offshore developments.

Table 3.1 gives an overview of some of the largest currently available wind turbines on the market. It is worth noting that the products listed in the table do not necessarily represent specific offshore designs. Sizes range from 2 to 2.5 MW rated power with rotor diameters of approximately 70 – 80m. Hub heights above sea level varying between 60m and 80m are in general expected to be somewhat lower than hub heights for onshore machines of the same power rating – due to the wind speed profile offshore that allows only for relatively small increases in wind speed with increasing hub height (see section 2.3.2). In the offshore situation, minimum hub height above sea level depends on the requirement of ensuring a minimum air gap of 1.5 m between wave crest and any structure that cannot suitably be designed to withstand wave impact [2]. In most designs this will be some kind of staging at the lower part of the tower from which personnel can reach into the interior. The staging must be kept clear of the rotor swept area to allow personnel to stand on it safely. It should be noted that the distance between seabed and rotor axis may assume considerably increased dimensions in the offshore situation as water depth will have to be added to the hub height above sea level, i.e for water depths around 30 - 40 m total support structure heights from sea bed to rotor axis will amount to some 100 m.

Manufacturer	Bonus	NEG Micon	Nordex	Enron Wind	Vestas
Type	Bonus 2 MW	NM2000/72	N80/2500 kW	EW 2.0 Offshore	V80 –2.0 MW Offshore
Rated power [kW]	2000	2000	2500	2000	2000
Rated wind speed, [m/s]	15	14	15	13	15
Rotor diameter [m]	76	72	80	70.5	80
Rotor speed [rpm]	11/17	12/18	variable, 10.3 -19.2	variable, 12.4 –23	Variable, 9 - 20.7
No of blades	3	3	3	3	3
Hub height [m]	60 or site specific	acc. to approvals	60-80	site specific	60-78
Power control	CombiStall	Active-Stall	Pitch Control	Pitch Control	Pitch Control / OptiSpeed

Table 3.1 : Selection of largest wind turbines (on- and offshore) on the market as per 9/2000.

As table 3.1 describes the state of the art, even larger offshore wind energy conversion systems (OWECS) are currently being developed e.g. the 5 MW MULTIBRID OWECS [4]. These future large scale, multi-megawatt machines will probably have sizes of 3 to 5 MW with rotor diameters of 80 – 110m and will feature hub heights above sea level of approximately 80 m. However, the authors expect that such large OWECS will not be available before the year 2003. It is crucially important that any new design be thoroughly tested on land before moving offshore.

## **3.2 Marinised Wind Turbine Design**

In order to be fit for use, onshore wind energy conversion systems will have to undergo conversion for marine conditions - marinization - before they can be deployed offshore. In this respect design options for rotor tip speed, number of rotor blades, operational strategy (variable speed vs. fixed speed operation) and overall machine design are discussed.

### **3.2.1 Rotor Speed**

Rotor speeds for state of the art onshore turbines are optimised for minimum noise emissions. In the offshore environment the optimisation target may be changed to optimal aerodynamic efficiency. Another benefit of increased rotor speed can be gained with respect to reduced drive train, gearbox and tower top masses as the rated torque to be transmitted may be reduced [3,6]. Increased rotor speed may also lead to reduced rotor solidity and hence reduced rotor blade area. With reduced rotor blade area, loads arising from extreme wind conditions during idling or stand still are reduced. With lower turbulence levels, reduced wind shear offshore and smaller torque, newly optimised rotor blade designs may offer considerable potential for cost reductions on rotor and drive train [3].

### **3.2.2 Variable Speed Operation**

With high tip speed rotor designs, fixed speed operation is associated with high cut-in wind speed and relatively high aerodynamic losses[6]. These effects may be overcome by the use of variable speed operation as the wind turbine only operates at maximum speed in wind conditions around and above rated wind speed. In addition it allows the control system to avoid resonance in the dynamic response of the wind turbine structure (occurring as a consequence of variable foundation stiffness) through exclusion of the concerned resonant rotor speed ranges. Such divergence of foundation stiffness from the assumed design value may arise due to insufficient spatial knowledge of the sea bed properties.

### **3.2.3 Number of Rotor Blades**

Most of the current designs have three bladed rotors, but with reduced requirements for noise and visual impact, also two blades are also an option. For a two bladed rotor, higher aerodynamic losses at the blade tips must be envisioned. At the same time there one component less to be manufactured, transported and erected, which leads to cost reductions. At present it seems still under debate whether or not a two bladed rotor will allow for an overall reduction in the kWh-price [4,6].

### **3.2.4 Machine Design**

In the context of overall offshore machine design, questions such as the optimal location of the transformer, proper protection of the machine components against marine environment and necessity of lifting gear are discussed.

#### **Protection against Marine Environment**

As the marine environment is characterized by the presence of water and salt, high humidity in the ambient air conditions, as well as spray covering the turbine's outer surfaces, an effective protection of the turbines against corrosion and harmful deposits is needed. In the North Sea icing of the rotor is considered to present a minor problem and is hence not considered in detail.

To protect the turbine's outer surfaces from the above stated influences, a proper coating of the exposed components will be required. The most suitable way to accomplish this may be to use

heavy painting systems as commonly used in the offshore industries or other surface protection techniques like electrozinc coating or petroleum based agents [3,7,8]. To ensure the appropriate protection for the individual design, corrosion classifications are available according to Danish Corrosion Classes and according to ISO 12944-2 with appropriate classes Cx [7,8]. Other non-load-carrying outside equipment like ladders, railings, bolts and nuts and so on should be of non-corrosive material. The goal should be to ensure corrosion protection for at least 10 years and for service life in the case of major structural components like the tower, nacelle and machine frame [3].

Electronics and other electrical components such as the generator, transformer, cable connections and switch-gear are located inside the nacelle and are therefore generally protected from marine environment influences. In order to ensure a proper protection against vapour and salt in the ambient air the nacelle may be sealed (not air-tight) and possibly pressurized [3]. At the air intakes dehumidification and heat exchanging devices for air conditioning will most likely be found and designed in two stages to ensure redundancy and adequate throughput [3,7]. Special provisions will have to be taken for the generator, gearbox and transformer cooling air to be separated from the nacelle interior. For the gearbox oil cooling an oil/air heat exchanger may be installed outside the nacelle. The generator and transformer may be equipped with an air-to-air heat exchanger in order to keep the ambient air containing salt and vapour away from their interior.

### Lifting Equipment

In most cases the marinized OWEC will be equipped with some kind of lifting gear. The idea is to be able to carry out replacements of all major components including generator, gear box, bearings and transformer [3,7,8,9]. The lifting gear comes in various types and sizes. There may be smaller cranes that are able to lift up parts for an even larger crane. In the alternative, the nacelle may be already fitted with sufficient crane capacity to be able to lower/lift all major components. As an example, the Enron Wind 2.0 MW offshore turbine uses an 8.5t gantry crane that may even be used for rotor blade assembly/dismantling. This way deployment of an expensive floating crane may be avoided. Further lifting gear will most likely be provided at the access platform at the tower bottom, to be able to transfer heavy equipment from and to the service vessel [3,10].

All designs must have either oversized doors and/or other removable coverings in order to have heavy and large equipment lifted into or lowered from the inside of the nacelle to the servicing vessel below.

### Location of Transformer and other Electrical Gear

In the onshore situation the transformer and other electrical components such as inverting systems or switch gears are sometimes found in separate housings outside the wind turbine. Of course such an arrangement is impossible for offshore applications. Hence all electrical components including the transformer, inverter and switch gear must go into the turbine's tower or at least on the turbine's support structure. In some cases the transformer is found in the nacelle (Vestas V80[8], NEG Micon NM2000/72 [11]), in other cases it is located in the tower base (Bonus 2MW). Another solution is to concentrate all electrical equipment (transformer, inverter, high voltage switch gear) and control electronics in a separate air conditioned container, that is mounted on the access platform at the tower bottom high enough as to avoid serious wave impact (Enron Wind 2.0 Offshore [10]).

### Boat or Helicopter Landing Facilities

Obviously any offshore site wind turbine will have to provide for secure and easy access for service personnel. In most cases this will be accomplished by a boat landing facility (see Figure 3.2). It consists of a ladder with two fenders and a shock cell to absorb impact from the landing boat, which will probably be a smaller craft deployed from a larger service vessel operating in the wind farm or from a purpose built service platform (see also section 3.5 Building Effort & Maintenance Considerations). From the boat landing, the ladder will lead to an access platform around the tower base well above the splash zone.



If helicopter landing is to be enabled, an extra heli-deck must be provided. This will most probably be on the nacelle or could also be some larger deck at the tower bottom level well above the splash zone. A two bladed rotor might be advantageous when a helicopter is to actually land on the nacelle, because it can be positioned and parked horizontally in order not to pose a hazard to the landing aircraft. However, as helicopter transfer is a very expensive way to access the wind turbine it is unlikely that full helicopter landing facilities will be standard.

### 3.2.5 Control System

In any case the wind turbine's control system must allow for complete reprogramming from ashore and for automatic reboot after grid failure. The quality and robustness of the remote access scheme will have a decisive influence on wind turbine availability and on maintenance cost as transfer to and from the faulted unit will be associated with considerable cost (vessel, helicopter, cruising time).

### 3.2.6 Power Supply Unit

When the grid that normally supplies power to the wind turbine is lost some backup power will be necessary to park the turbine. This backup power may be supplied through batteries (any electrical manoeuvres) or even by stored-energy spring mechanisms or by hydraulic accumulators depending on the device/actuator to be supplied. These short term backup systems, however, only ensure that the turbine is parked in a safe condition. In order to ensure manoeuvrability and communication to the wind turbine even throughout several months dedicated emergency generating sets are a must in the offshore situation.

## 3.3 Marinised Wind Farm Design

The wind turbines in a wind farm may be arranged in rows or in clusters. In order to obtain an optimal arrangement three effects will have to be taken into consideration [3]:

- Energy losses for wind turbines located within the wind farm due to lower mean wind speeds in the wakes of upstream wind turbines.
- Increased fatigue loads on the wind turbine within the wind farm in response to operation in the turbulent wakes of upstream wind turbines.
- Cost for cabling between the individual wind turbines (cost for cable, laying of the cables and power loss along the cables).

In the offshore situation wind farm effects i.e. decreased mean wind speed and increased turbulence within the wind farm are more pronounced. Due to lower ambient turbulence intensity the recovery of the flow behind an upstream turbine to ambient wind speed conditions will take longer as compared to the onshore situation. Therefore offshore wind farms with equal spacing to an onshore wind farm will have a reduced farm efficiency.

As the relative increase of turbulence in the wake of an upstream wind turbine is found to be considerably larger in the offshore wind farm [12] than in onshore conditions, the relative increase in fatigue loading is equally more severe.

Both of the above findings provide incentives to have offshore wind farms laid out with larger distances between the individual wind turbines. As land use offshore seems to be less restricted, a wider spacing may be adopted in favour of a better overall wind farm performance. It is hence expected that the typical onshore spacing of 4-5 D (D=rotor diameter) within a row perpendicular to prevailing wind direction and 8 D between rows (i.e. along prevailing wind direction) will be increased to approximately 8 -10 D in both directions.

In response to the third bullet above, it should be noted that improvements of wind farm performance due to a wider spacing must be balanced with the increase in cost for cabling within the wind turbine array.

The optimum size of an offshore wind farm will be much larger than onshore due to the relatively high cost for grid connection. As the cost for installation of an undersea cable is mostly dependent on the length of the cable rather than its capacity rating, overall cost performance will

benefit from larger wind farm sizes [1,3]. The actual number of turbines to be installed within a single wind farm in one stage is currently estimated to be about 100 turbines. This quantity is expected to be equal to the annual output of a single wind turbine factory and may well be installed and commissioned within one construction season [13]. The complete development of an offshore wind energy conversion facility may include several such stages. However, with respect to grid connection requirements it must be kept in mind that the onshore grid must have a suitable grid connection capacity.

### 3.4 Support Structures

The following section is devoted to a review of available support structures for offshore wind turbines. The term support structure refers to the complete assembly of foundation and wind turbine tower. As identified in section 4. Economics, the foundations are found to be one of the cost drivers in offshore wind energy development. They account for approximately 16% of the total cost for an offshore wind farm [14]. Hence, a strong incentive is given to develop cost efficient support structures.

In general two major groups can be distinguished:

- bottom-mounted support structures
- floating support structures

Obviously the decision of which option to use will depend on water depth. As those areas of the North Sea that are expected to be developed for wind energy use in the near future will have rather moderate water depths of up to say 40 – 50 m the focus is placed on bottom mounted structures. Nevertheless section 3.4.4 will briefly discuss floating support structures as well.

In existing offshore wind farm developments only bottom mounted support structures of the gravity based type (e.g. Vindeby and Tunoe Knob, Denmark) and the monopile type (e.g. Bockstigen, Sweden and Blyth Harbour, UK) have been used. The various options for the foundations and some of their specifics are presented in the following.

#### 3.4.1 Gravity Based Support Structure

In the context of offshore wind energy use, gravity based foundations represent the traditional solution. As the name indicates, the gravity force of a concrete caisson is used to keep the complete structure (foundation and wind turbine) in an upright position while being exposed to the overturning moment from wind and wave impact on the turbine's rotor and the support structure itself (see figure 3.1). It is important to note that there are no tensile forces acting between the caisson and the sea bed. This foundation type is found to be sensitive to extreme hydrodynamic loading as substantial heave loads may occur during passage of waves [3]. Wave heights in turn are dependent on water depth and thus weight of the foundation will have to be heavily increased with deeper water sites. The part of the structure penetrating the water surface is designed in a conical form to reduce ice impact in ice invested waters. Although extreme ice loading may be the design driving factor in some cases it is of no importance in North Sea sites. It is assumed that this type of foundation is commercially unfavourable in water depths in excess of 10 m [15] while physics constrain its use over some 20 m [3].

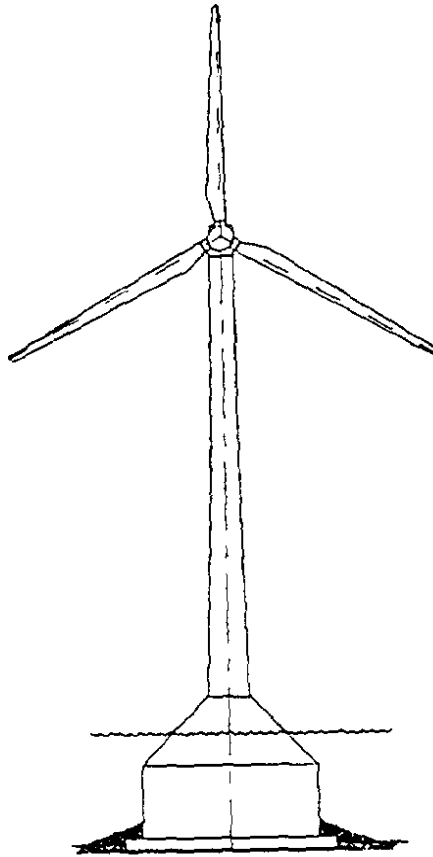

Fig. 3.1 Gravity based support structure [16].

Gravity based support structures provide rather stiff foundation properties, thus allowing little aerodynamic damping (i.e. damping of the fore-aft motion of the structure due to the adverse changes in the aerodynamic forces on the rotor in response to support structure motion). It also allows limited tuning of the support structure's dynamic characteristics [3]. The fatigue life of the gravity based support structure (foundation and tower of the turbine) is expected to be dominated by aerodynamic loading owing to stiffness of the concrete foundation. However, at extreme conditions at deep water sites with increased wave heights hydrodynamic loading will gain in significance.

The gravity based foundation requires sea bed preparation to be carried out, contributing to a rather large cost increase with water depth. The sea bed must be levelled and prepared with a layer of crushed stones. In sites prone to scour some kind of protection against erosion will be needed. This can be done by placing boulders at the edges of the base. In theory the foundation may easily be removed after service life, however, in practice suction effects may make lifting operation of the deballasted structure difficult.

The common technique is to build these caisson foundations in a dry dock and to float them out to the site of use after completion. In order to facilitate the transport, the caissons may be hollow and ballasted on site with sand, gravel, concrete or olivine (a very dense mineral) to achieve the required weight [15]. During transport these foundations may require extra buoyancy devices to ensure stability[3]. For a 1.5 MW reference turbine the weight of the ballasted concrete caisson will be some 1500 tonnes depending on site conditions. However, in the case of the Middelgrunden wind farm, fully ballasted concrete structures were also transported to the site using a heavy crane vessel [17, priv. comm. with the project manager].

Obviously the large weight of gravity based concrete foundations pose considerable demands on transport and installation procedures and in addition require temporary construction sites near the final wind farm location [16]. Also the effort for casting, formwork and maintenance of the construction site are considerable for concrete foundations. Hence, a solution to cut costs these respects is a steel structure consisting of a circular frame with internal stiffeners and a centrally mounted steel column to take up the wind turbine tower [16]. This structure weighs

considerably less, some 100 tonnes, before being ballasted at the site of deployment and may be manufactured at several even distant ship yards. During installation a number of these structures will be placed on a barge and shipped to the site. There they will be lowered to the prepared sea bed by a crane vessel and ballasted and sealed by another vessel. Due to the rather light weight of the structures, the same crane as used for turbine assembly may be used for their installation.

The described foundation technique has been used in the first two Danish offshore wind farms Vindeby and Tunø Knob, all in the form concrete caissons. A new 40 MW offshore wind farm that is to be installed at Middelgrunden just outside the Port of Copenhagen in autumn 2000 will also use concrete caisson gravity base foundations. In all cases water depths are between 2.5 and 7m and wave loading is hence moderate. At Middelgrunden the dry dock used for casting the concrete caissons is within viewing distance.

### 3.4.2 Monopile

Piled foundations represent the most commonly used solution in conventional offshore industries. The pile, a simple steel tube, is driven into the sea bed by means of a vibrating or piling hammer and enables lateral and axial forces (tensile as well as compressive) to be transferred to the sea bed. In offshore wind energy, a monopile support structure would consist of the pile, the tower of the wind turbine and possibly a connection element between both. Pile diameters are about 3 to 4.5 m and the piles have weights of 100 – 400 t depending on the design philosophy and turbine size [3, 15, 16]. Pile penetration into the sea bed will be about some 18 - 25 m. Maximum water depth for monopile support structures is identified to be approximately 25 m [3].

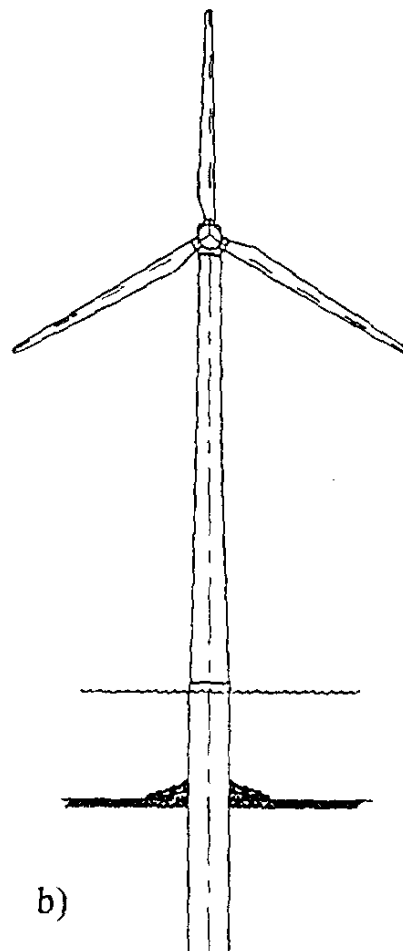

Fig. 3.2 Monopile support structure [16].

The monopile support structure represents a rather soft design with respect to foundation stiffness. As such it offers significant advantages with respect to aerodynamic damping (see

3.4.1 Gravity Based Support Structures for explanation) and reduced dynamic response. Such rather soft foundation characteristics offer the potential of considerably reduced fatigue from aerodynamic loading (rotor) if the support structure dynamic characteristics are properly tuned. However, it must be noted that with a structural resonant frequency closer to wave excitation frequencies an increased portion of fatigue from hydrodynamic loading must be accepted [3]. In general the design is expected to be fatigue driven, however, in ice invested waters, extreme loads from drifting ice may also require increased wall thickness [16]. The Danish Wind Manufacturers Association [15] specifies wave heights as the design governing site condition.

The monopile does not require sea bed preparation but is sensitive to scour. Therefore in regions prone to scour some form of protection such as artificial seaweed or shingles will be needed. Piling is restricted to sea bed conditions with no or only few boulders, as they might cause problems during piling. For very stiff sea bed conditions drilling will be required. In such a case the monopile will be slotted into the drilled hole and grouted. With respect to corrosion it is interesting to note that below seabed line no coating will be used on the monopile, in order to provide adequate friction between pile and soil. However, for other foundation types cathodic protection is most likely to be applied by either using passive sacrificial anodes or active impressed current. No anti-fouling will be used on the monopile. Removal of the monopile from the sea bed may be accomplished by cutting it some meters below mud line or by extracting it from the sea bed using a vibration hammer.

Due to the simplicity of the structure no specialized fabrication method is required: tube rolling facilities are available in a large number of steel mills.

Transport to the site will be carried out in batches of piles on a barge. The piling equipment is operated from aboard a floating vessel or a jack-up platform and requires a crane with sufficient lifting capacity to handle the pile (e.g. some 280 t for a 3 MW turbine) and the hammer (500 – 700 t). In [16], the duration for the installation of a monopile using a jack-up platform in the demanding North Sea environment is estimated at 30 hours [16]. Thus the technique of using monopile support structure is rather optimized with respect to the duration of the installation. With respect to cost, only a moderate increase of cost with water depth is expected. However, in situations with very stiff soil conditions cost of piling will be increased. [16].

The monopile support structure has been used in the Bockstigen project, an offshore wind farm south of the Swedish island of Gotland. In that project five 0.5 MW turbines have been installed on monopiles that have been slotted into drilled holes of 8 to 10 m depths.

### 3.4.3 Tripod

The tripod support structure has its origin in the offshore oil & gas industry. The structure is made of a centre column that carries the tower and a steel space frame transferring the loads from the tower to mainly tension and compression loads in three piles that are driven into the sea bed and connected to the frame through sleeves at the three corners. The cylinder between piles and pile sleeves is filled with grout after piling to ensure rigid connection. At some 0.9m the pile diameters used in this arrangement are much smaller compared to the monopile. However, penetration depths are of similar size depending on sea bed conditions (e.g. some 10 - 20 m [16]). The centre column has a reduced diameter at sea level to reduce wave and ice loads.

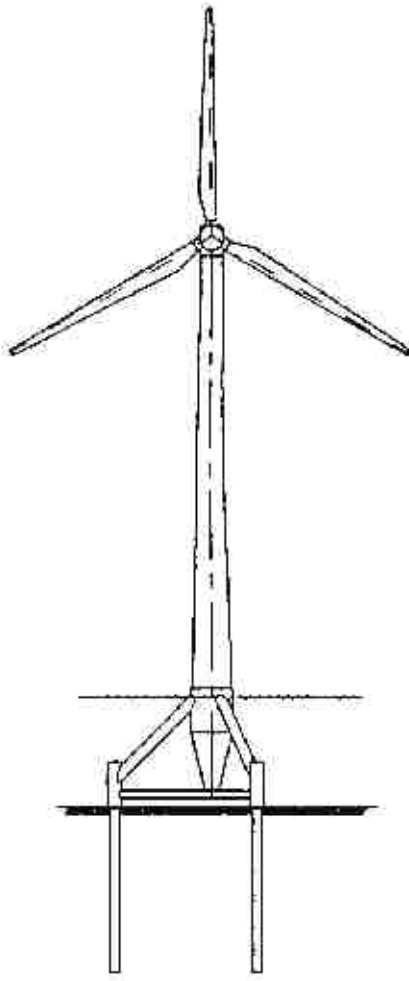

Fig. 3.3 Tripod support structure [16].

As the tripod represents a light-weight structure dynamic behaviour must be carefully examined. It is a rather stiff structure with smaller allowance for aerodynamic damping (see 3.4.1 *Gravity Based Support Structures* for explanation) to reduce dynamic response when compared to the monopile. Wave loading has been shown to play a rather insignificant role in water depths down to 11 m (some 10 – 25% contribution to the overall overturning moment [16]). Hence the tripod support structure is mainly governed by aerodynamic fatigue loading. Again, importance of wave loading will probably rise with deeper waters. Loading from ice crushing against the structure can be design driver but may be considered of minor importance in the North Sea environment.

The tripod is well suited for greater water depth. Problems arise when it is placed in shallow waters with depths below 6 - 7 m because the requirement for sufficient water depth for service vessels to approach the structure without running the risk of hitting a member might not be met.

The structure has to be manufactured in a ship yard or similar and involves in general only well known and proven techniques. Some complexity is added to the manufacturing process with respect to the intersections of braces to the centre column. As the overall weight and size are moderate, manufacturing at greater distances from the site of deployment is considered to be possible [16].

For the tripod no sea bed preparation is needed. Installation requires piling equipment and crane facilities to lift the structure with pre-inserted piles and the piling hammer. With respect to corrosion it is worth noting that below seabed no coating will be used on the piles, to provide adequate friction between pile and soil. However, as for the monopile cathodic protection is most likely to be applied by either using passive sacrificial anodes or active impressed current. No anti

fouling will be used on the structural members. After use it can be removed from the sea bed by cutting off the piles, preferably below the mud line.

So far this support structure has not been used in wind energy applications, however, as it is most suited for greater water depth it has a potential for sites with larger distances to shore and hence deeper water to be developed. With respect to piling, the same considerations as stated for the monopile are relevant. With respect to cost only a moderate increase of cost with water depth is expected. However, in situations with very stiff soil conditions cost of piling will be increased. [16].

### 3.4.4 Floating Support Structure

An incentive to use floating support structures in offshore wind farm developments is the constraint to modest water depths necessary for any sea bed mounted structure. With floating support structures this drawback can be overcome and the development of offshore wind energy generating facilities could be extended to areas with water depths of up to several hundred meters.

This approach has been taken by several studies. Two studies, FLOAT [18] and MUFOW (Multiple Unit Floating Offshore Wind farm) [19], carried out in the UK, have been analysed for this report. These studies have been chosen because they present the two feasible options for floating wind farm developments:

- using buoy type support structures [18]
- using semi-submersible vessels [19]

#### The Buoy Type

In the case of buoy type systems the support structure comprises the tower, the hull and the moorings to the sea bed. The tower, a tripod steel space frame, is bolted onto the deck of a cylindrical buoy hull with a wider bottom disk for improved dynamic behaviour (see Figure 3.4). The buoy design for a 1.4 MW wind turbine with 45m hub height above sea level has 3570 t displacement and features a simple tubular reinforced concrete shell construction of 12 m in diameter. Furthermore, the buoy is ballasted with 660 t mass concrete in the lower part to provide stability when floating and 120 t synthetic foam in the upper section to avoid flooding in case of cracks in the outer shell. The mooring system is made up of 8 lines per unit adaptable to water depths between 75 and 500 m. The mooring lines (catenary chain or taut wire synthetic fibre rope) are to be connected to mooring anchors piled to the sea bed. A line tensioning system is to be mounted on the deck to allow tensioning of pairs of opposite facing lines during installation and during operation when needed. Once a pair of lines has been tensioned the lines will be locked off and the winches engage on the the next pair of lines and tension them.

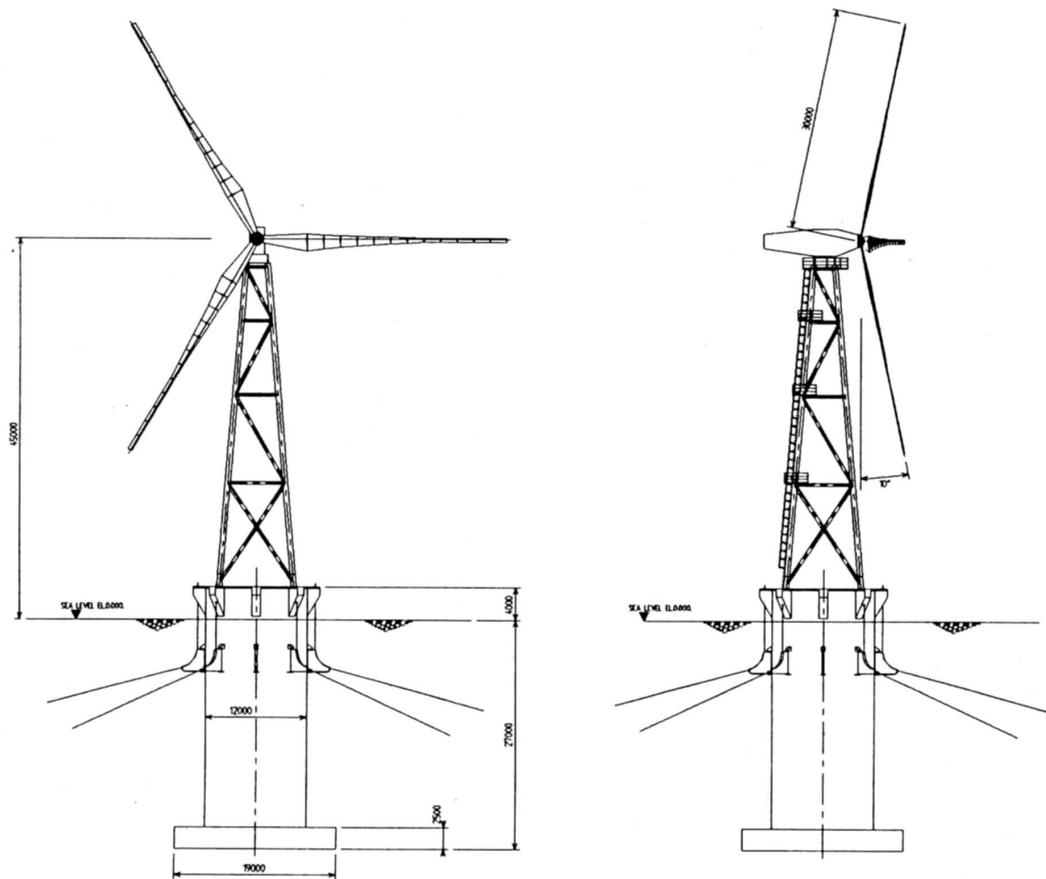

Fig. 3.4 Buoy type support structure [18].

The completed FLOAT structure (including wind turbine) would be floated out to the site of deployment where, in a first phase, mooring lines and anchors are already installed.

As the project is limited to a conceptual design development, no practical experience is available with systems as described. However, a comprehensive model test programme has been carried out demonstrating the feasibility of the proposed scheme.

### The Semi-submersible Type

As opposed to the afore-mentioned case the main semi-submersible support structure will be located below the water surface. This technique is well proven in the oil & gas industry and the deep submergence of the individual hulls arranged in a larger structure lead to a reduced response waves and which longer natural periods of motion. These characteristics are attributed to the wave kinematics to decay exponentially with depth. The hulls will be manufactured from reinforced concrete and braced to an overall structure capable of carrying a cluster of 3 – 6 multi megawatt wind turbines (rotor diameter of 80 m). These clusters can adopt various shapes to comply with different optimisation targets. The complete arrangement is to be moored by catenary chains to piled anchor points on the sea bed. Investigating the loads on the turbine in comparison to those found for turbines on bottom-mounted support structures has provided evidence of a dramatic increase in fatigue damage for the floating case. The use of the proposed MUFOW system is constrained to water depths between 75 and 500 m with the catenary chain mooring system.

### General Remarks

As a general remark on floating offshore wind energy systems it must be noted that performed cost analysis currently generate rather high electricity prices. As a crude estimate the price per kWh is approximately twice as much related to bottom mounted schemes. For floated wind farm systems the relative portion of the floating hulls and the mooring system is expected to be in the order of 40% - 50% of overall project cost [18,19]. Suitable deep water sites (75 – 500 m) in the North and Central North Sea will furthermore suffer from very long grid connection, installation



and operation and maintenance cost while the extra output amounts to some 13% compared to near shore sites in the UK [19]. All of this leaves floating wind energy conversion systems as an option that is considered to be technically feasible, but at present there is no incentive to take the extra cost for the exploitation of these deep water sites.

### 3.5 Building, Operation & Maintenance Considerations

#### 3.5.1 Construction Effort

To demonstrate the effort involved in constructing an offshore wind farm consisting of 100 turbines, the use of monopile foundations is assumed. As the power rating of the turbine is not decisive for the effort involved in piling, a development of 100 turbines may have a rated capacity of 200 – 500 MW depending on the individual turbine's power rating. It is assumed that the cables within the wind farm are not buried.

The season with suitable weather conditions for offshore construction work starts in early May and stretches until the end of August. This represents a total of 100–120 days that are available for offshore activities. Taking the figure from section 3.4.2 *Monopile* and adding some extra time for unexpected problems the piling will take two days per unit. Another two days period per unit is needed for the erection of the turbine itself. It is assumed that the laying of cables between the individual site in the farm and from the central substation to the mainland grid will be carried out in parallel to turbine installation.

With these assumptions an estimate of four construction teams and one cable laying team will have to be continuously on site to complete the farm within one season, i.e. one turbine will be completed per day. The extra 20 days may be regarded as a time buffer for unfavourable weather conditions or mobilising time. A construction team will comprise one jack-up platform or crane vessel plus one or more barges/pontoons that take up the piles/turbines. To move the jack-up platform, tugs are needed and of course there will be supply traffic to transport turbines, piles, cables and other material to the site. This will presumably lead to a steady traffic to and from the site, depending on the number of turbines and piles that can be transported on one barge at a time.

#### 3.5.2 Operation & Maintenance Effort

It has been pointed out earlier that the availability of the offshore wind energy conversion system (i.e. the wind farm) is to be maintained at a high level (currently possible in excess of 99% onshore). In order to achieve this target close monitoring of the wind farm operation together with appropriate maintenance will have to be performed. In [3] a number of maintenance strategies and options are discussed in detail. The work here will focus on some crucial aspects and will try to demonstrate the effort involved.

Generally, just as for wind farms onshore, the operation of individual wind turbines in the farm will be monitored by a remote control scheme. Such a monitoring system provides for remote access to the wind turbine's operating system and data logging facilities, and enables monitoring personnel to execute remote reset procedures if necessary. The wind turbine's operating system in turn will use remote communication lines to transmit any alarm condition to some control room. Such communication may be established through dedicated cabling, radio transmission or by transmission of modulated signals on the power lines.

It is most likely that the current maintenance strategy for onshore wind turbines, including both preventive and corrective maintenance, will be kept up [20]. However, some adjustments to the offshore situation are expected.

Preventive maintenance (PM) includes regular inspections and exchange of spare parts (wear). Onshore, typical intervals for such preventive maintenance are 6 months. Responding to reduced access combined with better monitoring of the machines, these intervals are expected to be doubled to once per year and unit. Additionally, every 5 years a larger preventive maintenance is scheduled that will include examination of the rotor blades and thus might require external cranes (if not available on board). PM will be scheduled to the summer season as to cause minimum energy loss due to maintenance downtime.

Corrective maintenance (CM) will be undertaken whenever a fault occurs that stops the machine and causes downtime. In order to detect such faulted conditions, the above mentioned monitoring techniques are to be further developed for offshore applications. There are estimations of 18 months for mean time between failure (MTBF) provided that PM is carried out regularly as well as on occasions of CM.

In a farm of 100 machines there will be PM activities for at least one unit every day during summer season (May – End of August) if yearly PM intervals are assumed. As corrective maintenance increases the effort even more, it is very likely that there will be two or three maintenance teams present on the site throughout the year [3].

The scenarios on how these teams will move, work and live differ. There may be a stationary platform in the farm to house the teams and to serve as storage or workshop facility. Such a purpose built platform may be combined with the transformer substation to save on initial investment cost. If a dedicated platform is used smaller service vessels will have to transport the teams from unit to unit. Another option is to have a larger maintenance vessel constantly on site moving around the array. Again most probably smaller boats to access the individual turbines are necessary. A third option may be to have a self propelled jack-up platform on site featuring housing, workshops, storage and crane facilities. In the other two options external cranes might be needed when for example rotor blades must be changed.

According to [3], helicopter access from an onshore base to the wind turbines on a regular base is ruled out because of cost. Even when the downtime of the turbine to be serviced is taken into consideration, the vessel cost and lost revenue due to downtime do not outweigh the cost of helicopter transport.

### **3.6 Grid Integration**

As discussed before, issues of reliability and availability are much more important for offshore wind farms than for onshore wind farms: In case of faults a long time period may elapse before corrective maintenance measures can be carried out. Thus fault-free operation must increasingly be considered for the grid connection of offshore wind turbines as well.

The technical implementation of offshore wind farm grid connection will first of all be governed by the parameters of installed power and distance to the coast. Within the offshore wind farm the wind turbines will presumably be connected via a medium voltage line as is the case for onshore wind farms. For small offshore wind farms very close to the coast, the connection of the wind farm to the grid can be realised by one or several medium voltage lines. In this case the use of submarine cables presents the only difference to onshore wind farms. One example for this type of grid connection is the offshore wind farm Tunø Knob in Denmark, where 10 Vestas V39 500 kW wind turbines are connected to the grid by a 10 kV medium voltage submarine cable of 6 km length [21].

Future offshore wind farms are expected to have much larger capacities of up to 1000 MW and to be located considerably further away from the coast. These wind farms must be connected to the grid via high or extra high voltage lines. Thus offshore substations on separate platforms at the wind farm sites will become necessary to transform the medium voltage of the wind turbines to high or extra high voltages.

The offshore wind farm's substation may be connected to the mainland grid by a three-phase A.C. (alternating current) submarine cable. For large distances and/or for high power, however, A.C. connection is penalised with rather high losses. For distances more than approximately 50 km (depending on the type of cable and the voltage level) A.C. connections will be very difficult or impossible due to the loading current from the reactive power production of the cable itself. As alternative high voltage D.C. transmission (HVDCT) may be employed. Here the coupling between the offshore wind farm and the onshore grid will be made through a D.C. (Direct Current) link. The electrical losses for D.C. transmission are lower than for A.C. transmission and loading currents are not a problem. However, additional expenditure is inferred for rectifying and inverting voltage.

The electrical set-up within the wind farm can be done in a similar way to an onshore wind farm. The wind turbines will be interconnected medium A.C. voltage lines. Each of the wind turbines will be equipped with a step-up transformer from the wind turbine's low voltage system (below 1 kV) to medium voltage levels up to 36 kV. This transformer and related medium voltage switch-gear will be installed inside the wind turbine's tower and/or nacelle. Wind turbine types of this

design already exist. With respect to medium voltage switch gears, gas-insulated devices bear advantages due to moderate space requirements and due to better offshore features. The transformer may be of liquid filled type (oil-cooled), but also cast-resin transformers are available.

For large wind turbines the output voltage and the nominal voltage of the generator may not be low but medium voltages in the range of 6 kV. To date there exists no wind turbine type with direct medium voltage generators and all of today's largest wind turbines in the range of 1.5 MW up to 2 MW have nominal generator voltages of 690 V (i.e. low voltage). Currently the reason for this is probably the higher expenditure for the medium voltage technology, however, medium voltage technique inside the wind turbines are expected to become standard for large offshore turbines.

It is unlikely that high voltage technique (above 36 kV) will be used for the connection of the wind turbines within the wind farm due to the considerably higher associated technical and cost expenditure. Transformers from low voltage directly to high voltage are not common and thus more expensive. Furthermore, high voltage switch gears are much more expensive than medium voltage switch gears and require more space.

An alternative to transmission within the wind farm may be a D.C. link between the wind turbines. In this case special design of the wind turbines or additional equipment (rectifier) will be required. D.C. interconnection will avoid synchronising effects of wind turbines among each other and will allow for variable speed of the wind turbines. Up to date no such D.C. interconnections within a wind farm have been installed and no special D.C. connection design of the wind turbines is available. In addition, more expenditure will be necessary to transform medium D.C. voltage to high D.C. voltage.

Typical layouts for the connection of the wind turbines within the wind farm are given in figures 3.5 and 3.6. The submarine cables within the wind farm are not necessarily laid underground provided that shipping is restricted or completely banned within the wind farm.

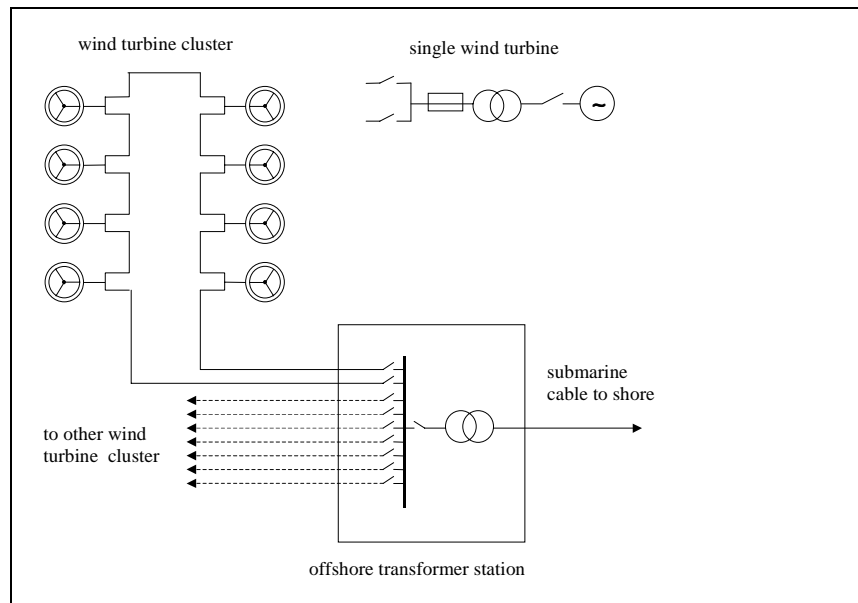

Fig. 3.5: Connection of the wind turbines by a ringed network.

In figure 3.5 the wind turbines are connected by a ringed network. This layout gives redundancy, in case a failure of a cable occurs. The faulted cable section can be replaced while all wind turbines are still in operation. In the case of the radial network, fig. 3.6, the failure of one section could lead to loss of production of one to several wind turbines. Due to adverse weather conditions the repair could possibly take several weeks causing severe production losses. However, first investigations [22] show that the loss of production for offshore wind farms on average is expected to amount to moderate 0.026 % of the ideal annual energy production. Thus radial networks as shown in figure 3.6 provide a cost effective alternative for the connection within wind farms

The maximum size of one wind turbine cluster (see figures 3.5 and 3.6) will be in the range of 30 MW up to 40 MW for technical reasons (cross-section of the cables).

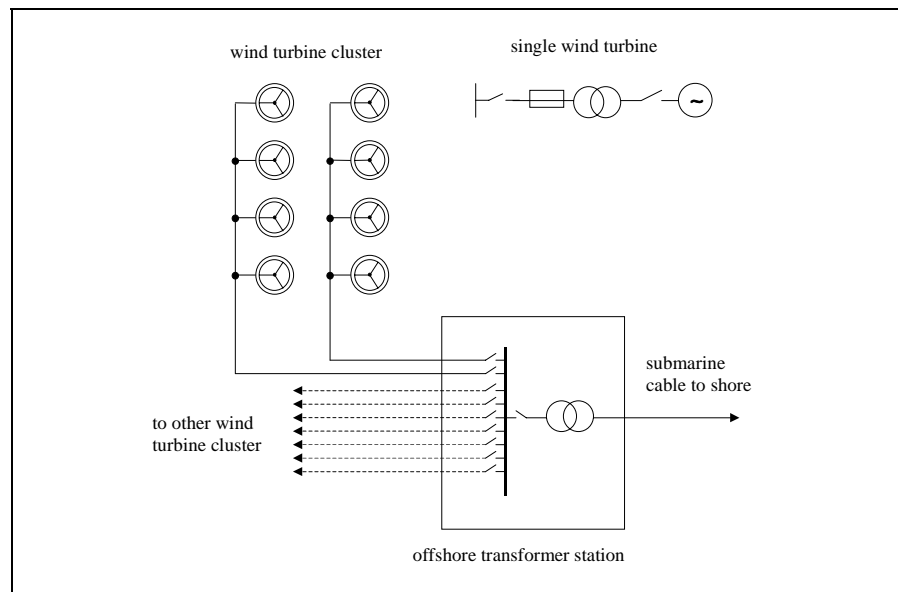

Fig. 3.6 Connection of the wind turbines by a radial network.

### 3.6.1 Transmission from the Wind Farm to the Grid

As introduced above, there are two alternatives for the transmission of wind generated electricity from the offshore wind farm to the mainland grid:

- high voltage three phase A.C. transmission
- high voltage D.C. transmission (HVDCT)

A.C. transmission is a well known technique, but it bears disadvantages for large distances. HVDCT on the other hand requires further expenditure for voltage rectification and inversion. Very large offshore wind farms and long distances are expected to make HVDCT more economic than A.C. transmission solutions. In [23] a break-even distance of approximately 50 km is specified for offshore HVDC.

It is obvious that neighbouring offshore wind farms should have one transmission line to the mainland grid. Neighbouring wind farms should be connected to each other by medium or high voltage systems (depending on the distances). As a future perspective a dedicated offshore electrical network can be envisioned, interconnecting all or most of the offshore wind farms and requiring only a few transmission lines to sites of the mainland grid. Such an offshore network could use HVDC techniques, enabling integration of existing or future HVDCT (like the Viking cable, Eurokabel). It would provide redundancy for the individual wind farm in case of a transmission line failure. It is clear that such an offshore HVDC grid would require sustainable national and international planning rather than individual planning for individual offshore wind farm projects.

### 3.6.2 High Voltage Three Phase A.C. Transmission

The connection of large offshore wind farms to the grid by a three phase A.C. transmission line can be split into three parts:

- the offshore substation
- the submarine cable
- the onshore connection to the mainland grid (onshore substation).

### 3.6.3 The Offshore Substation

The offshore substation will be somewhat different from conventional onshore substations, while the technique is well known and available.

An offshore substation is needed for the transformation of the medium voltage of the wind farm network to the high voltage of the transmission line. The substation will be installed on a platform similar to the structures used in the oil and gas industry. The space demand for the substation is approximately 200 m<sup>2</sup> per 100 MVA power [24].

To date, no offshore substations have been erected. The substation itself must be protected against the influences of salt water and other environmental influences and of course losses of oil from the transformers must be avoided. Thus the construction of these substations will be different from onshore substations and costs can be expected to be higher. The technique, however, is well known and available (e.g. gas-insulated techniques).

The voltage level of the substation may be up to 400 kV, depending on the transmitted power and on the voltage level of the onshore substation. The transformer will be oil-cooled, possibly with two secondary windings, each with half the transformer's nominal rating. This arrangement will keep the short circuit power level at medium voltage down to a manageable level with respect to the selection of medium voltage equipment [25].

In case of grid faults an emergency power supply, such as a diesel generator unit, may be necessary. Of course the rating of such an emergency supply will be rather low.

Due to the large production of reactive power by the loading currents in the submarine cable, a reactive power compensation at the offshore substation is indispensable.

### 3.6.4 Transmission Line Between Offshore Wind Farm and Mainland Grid

A.C. transmission requires three parallel conductors, one for each of the three phases. There are four different types of submarine cable: single or three conductor oil-insulated cables and single or three-conductor PEX-insulated (PolyEthylene) cables [25]. In case of single conductor cables three parallel cables are necessary for the transmission line. In general the distance between the single cables is approximately 1 m. Today's maximum capacity for a three-phase A.C. transmission system with three conductor oil-insulated cables is in the range of 200 MVA at voltages of 110 kV or 150 kV [24], [25]. For single conductor oil-insulated cables the maximum transmission capacity is around 400 MVA (110 kV) [24].

Due to the loading current from the reactive power production of the high-voltage submarine cables, the length of an A.C. transmission line is limited to approximately 40 – 50 km [26] or 100 km [24], depending on the voltage level and the type of cable used. The reactive power production from the cable could be compensated, but it seems to be unlikely that such compensators will be installed offshore as an extra offshore platform would be required for each site of compensation.

The submarine cable between wind farm and shore should be buried in the sea bed to avoid the risk of damage due to anchoring, shipping or fishing devices. There are various techniques available to bury the cable such as washing in, jet trenching and others.

Between the point of landing on the shore and the point of connection to the mainland grid a high-voltage overhead line or an underground cable will be required. This line or cable may be identical to conventional high- or extra-high voltage lines of the grid.

### 3.6.5 The Onshore Substation

The onshore substation at the connection point to the mainland grid will be a conventional substation. Depending on the topography of the grid and on the transmitted power from the offshore wind farm an existing substation can be used or a new substation is required. If the high-voltage level of the offshore wind farm is equal to the voltage level at the grid connection point, then the onshore substation will merely consist of a high voltage circuit breaker for connecting/disconnecting the wind farm to/from the grid. In case of different voltage levels an additional transformer unit must be employed.

### 3.6.6 High Voltage DC Transmission (HVDC)

For transmission over large distances and/or for transmission of large power capacities the HVDC presents a more suitable technical solution than a three-phase A.C. transmission as described before. However, further equipment for rectifying from A.C. to D.C. and for inverting from D.C. to A.C. must be installed.

For rectification and inverting, two different technologies are used: the traditional thyristor based technology (see figure 3.7) and a new technology, based on IGBT (Insulated Gate Bipolar Transistor) with pulse width modulation (PWM).

Thyristor based inverters and rectifiers are used in a large number of existing HVDC systems. The largest one is the onshore installation in Itaipu, Brazil, transmitting 6300 MW in two bipoles over a distance of 800 km with an operating voltage of  $\pm 600$  kV [23]. Existing installations with submarine cables include the HVDC link between France and UK with a transmitted power of 2000 MW ( $8 \cdot 250$  MW) [26], [27], and the Baltic cable connecting the Swedish and the German grids: 600 MW, 250 km, 450 kV monopolar [26]. In addition there are plans for a three cable connection from Norway to continental Europe with a power of 3 times 600 MW [28]. The Baltic cable is a monopolar system, i.e. only one conductor is laid down between Sweden and Germany. As the return-line the water of the Baltic sea is used, which is an ideal conductor due to its large cross-section. In present projects and plans, however, only bipolar HVDC systems with two conductors are considered due to the requirement of minimising environmental impacts.

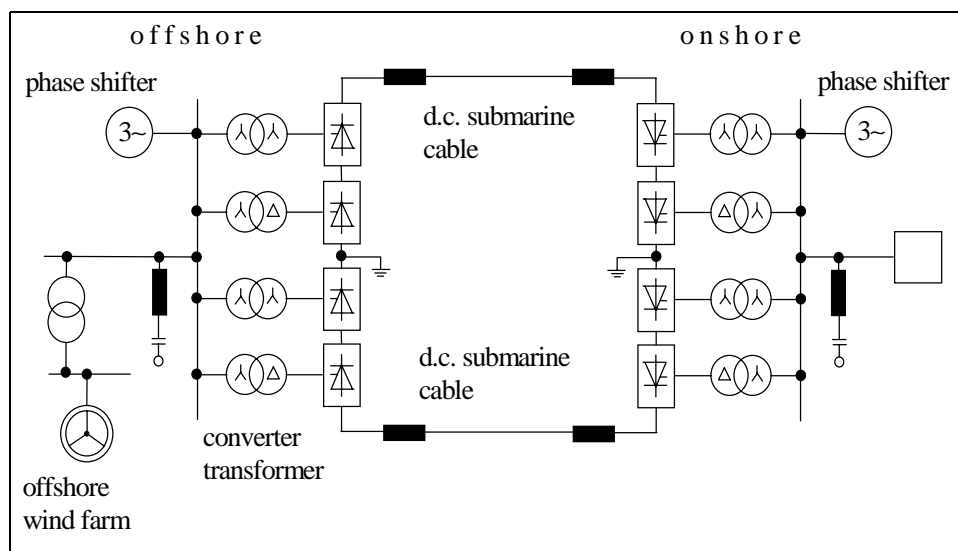

Fig. 3.7: Principle scheme of the high-voltage D.C. transmission (HVDC) with thyristor technique.

The thyristor technology has some disadvantages. One is the generation of high harmonic currents forcing the installation of large filter systems. The other disadvantage is that reactive power can not be generated in a controllable manner. The thyristor inverter demands reactive power, depending on the transmitted active power. It is however, not able to control or to generate reactive power. Thus reactive power compensators such as banks of capacitors and phase shifters are required offshore. Another major disadvantage may be that thyristor inverters are current source inverters, unable to create an A.C. voltage system on their own. They can only inject A.C. currents into an existing A.C. voltage system. For use in offshore wind farms autonomous A.C. voltage systems must therefore be created. For wind turbines with direct coupled induction generators large phase shifters (synchronous generators), controllable in voltage and frequency, are necessary to create the A.C. voltage system and to start-up and

operate the wind turbines. As variable speed wind turbines with PWM inverter systems are able to create an A.C. voltage system it should be possible to start-up and run these wind turbines independently.

Figure 3.7 gives the principle scheme of a HVDCT. Rectification and inverting will be performed by thyristor bridges offshore and onshore. On both sides (offshore at the wind farm and onshore at the grid connection point), reactive power must be compensated by capacitor banks and phase shifters. Harmonics must be filtered. The offshore equipment can be installed at the platform of the offshore substation. The transformer of the offshore substation will be dispensable provided that the offshore converter transformers are also used for transforming the medium voltage of the offshore wind farm to high-voltage.

At present, the highest HVDCT voltage scheme in service for submarine cables is 450 kV. A number of cable schemes with proposed voltages of 500 kV [23] are under consideration.

New PWM inverter technology with IGBTs is able to control reactive power and to create an autonomous A.C. grid, to which the wind turbines in the offshore farm could be connected. Thus voltage, frequency and reactive power of the offshore wind farm voltage system can easily be controlled. One such HVDCT with a rated power of 65 MVA [29] and featuring modern PWM inverter technology (called HVDC-light by the manufacturer ABB) has been installed at the Swedish island Gotland in 1999. Another project of 180 MVA rated power is planned between Queensland and New South Wales (Australia). It is obvious that for future large offshore wind farms the power of the PWM inverter systems must be increased. To date D.C. voltages up to 100 kV are possible for transmission lines using the HVDC-Light technology of ABB.

### 3.6.7 Point of Coupling to the Mainland Grid

Existing onshore wind turbines and wind farms are mainly concentrated in the coastal regions. In these regions the existing electrical high-voltage networks are mainly 110 kV or 150 kV voltage systems. In Germany for example, most of these high voltage systems are running at their full or nearly full capacity. Hence, for large offshore wind farms (in the range of some hundred MW) the only possibility is a connection to the extra-high voltage systems (220 kV or better 400 kV) which in general are not located directly on the coast. These extra-high voltage systems are available near the shoreline only at sites where large power plants (such as nuclear power plants) are also installed close to the coast. In other cases, additional extra-high voltage lines will have to be built. Figures 3.8 to 3.12 at the end of this section give an overview of the existing extra-high voltage systems in the North Sea coastal states.

Typical transmission capacities of 400 kV overhead lines are in the range of 2000 MW up to around 6000 MW for two line systems [30], depending on the type of mast and on the lines used. Of course the connections of large offshore wind farms to these extra-high voltage systems depend on the available free transmission capacity. These must be validated by load flow calculations.

In Germany for example, it has recently been decided in a national energy consensus that all nuclear power plants are to be taken off the grid within a few decades. One of the first to go offline (within a few years) is the facility at Stade in the coastal region of Germany with a capacity of 630 MW. This capacity and capacities of further nuclear power plants could be used for the connection of large offshore wind farms.

For HVDCT the length of the line does not depend on technical limits. Thus from the technical point of view it is not necessary to install the inverter system for the transformation from D.C. to A.C. immediately at the coast. It is also possible to directly lead the HVDCT to regions of large electricity consumption. Of course, the length of the HVDCT is an economic question.

### 3.6.8 Magnetic Fields

The current flow in the submarine cables causes magnetic fields, which may have an impact on fish and sea mammals (see chapter 5 *Environmental Impact Assessment*). The impacts could include influences on the species' navigation, on their migration and on their search for food. To date no detailed and comprehensive research on these impacts is available.

An extreme example of the generation of magnetic fields is the HVDCT "Baltic cable" between Sweden and Germany - a monopolar transmission system of 600 MW capacity with currents of up to 1330 A. The intensity of the magnetic field created by the cable at a distance of 6m has a value similar to the natural geomagnetic field in the Baltic Sea, which is about 50 Microtesla [26].

At the surface of the water directly above the cable, magnetic compasses show considerable deviations, which is why ship traffic is informed about the cable to avoid erroneous navigation.

For bipolar HVDC and for A.C. transmission the generation of magnetic fields will be much smaller due to the compensatory effect of the supply and return lines. In theory two lines with opposite currents emit no magnetic field provided that they are lying parallel and close to each other. The value of the magnetic field is influenced by the distance between the supply and return line. Thus a three conductor cable bears advantages compared to three single conductor cables. However, as pointed out above, the transmission capacity of three conductor cables is currently less than that of single conductor cables.







Fig. 3.10: High-voltage Grid of the northern part of Germany (PreussenElektra) [www.Preussenelektra.de]



Fig. 3.11: High-voltage grid of Denmark[www.Eltra.dk].

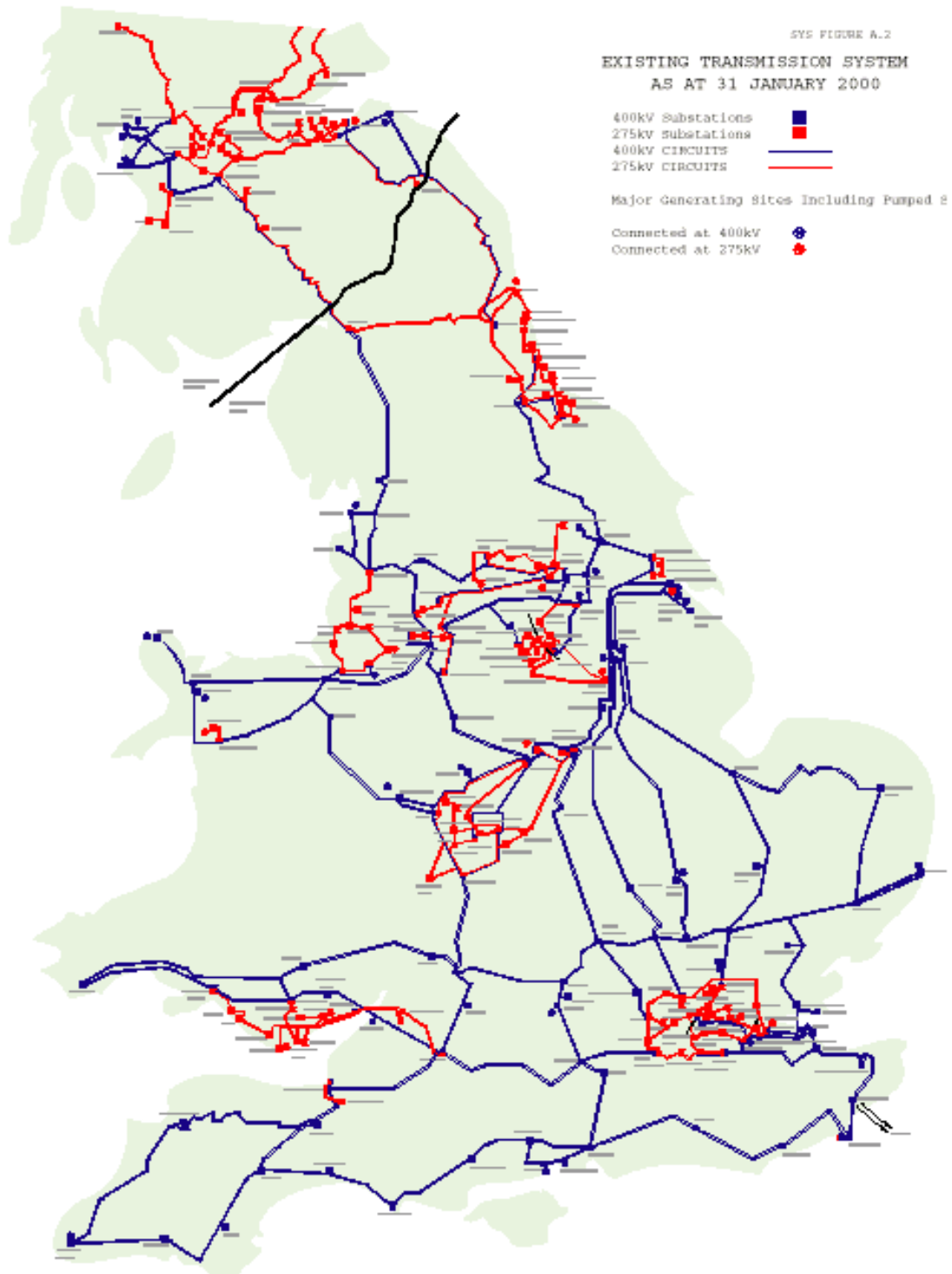

Fig. 3.12: High-voltage grid of UK [Bartholomew Mapping Solutions, Cheltenham, UK].

### 3.7 References

- [1] Krohn, Soren: Offshore Wind Energy: Full Speed Ahead. In: [www.WINPOWER.dk](http://www.WINPOWER.dk). Homepage of the Danish wind turbine manufacturers association, <http://www.winpower.dk/articles/offshore.html>
- [2] Germanischer Lloyd: Regulations for the Certification of Offshore Wind Energy Conversion Systems., Hamburg, Germany: Germanischer Lloyd, 1995.
- [3] Ferguson, M.C. (Editor): OPTI-OWECS. Volume 4 : A Typical Design Solution for an Offshore Wind Energy Conversion System. Final Report on Joule III contract JOR3-CT95-0087for the Commission of the European Communities, Delft, The Netherlands: Institute for Wind Energy, Delft University of Technology, 1998 (IW-98143R).
- [4] Rees, M.; Sancho, J.: Rotor Concepts and a New Structural Design for a Very Large Rotor Blade for the Multibrid OWECS. In: Ente per le Nuove Tecnologie, l'Energia e l'Ambiente ENEA (Rome) (Editor): OWEMES 2000 Proceedings. Rome: ENEA, 2000, p. 245-251.
- [5] Siegfriedsen, S et.al.: Development and Demonstration of a 5-MW Offshore Wind Energy Conversion System Using Multibrid Technology. In: Ente per le Nuove Tecnologie, l'Energia e l'Ambiente ENEA (Rome) (Editor): OWEMES 2000 Proceedings. Rome: ENEA, 2000, p. 543
- [6] Jamieson, P; Camp, T.R.; Quarton, D.C.: Wind Turbine Design for Offshore. In: Ente per le Nuove Tecnologie, l'Energia e l'Ambiente ENEA (Rome) (Editor): OWEMES 2000 Proceedings. Rome: ENEA, 2000, p. 405 – 414.
- [7] Matthies, H.G. et. al.: Study of Offshore Wind Energy in the EC. Final Report of Joule I contract JOUR-0072 commissioned by the Commission of the European Communities CEC, Verlag Natürliche Energien, Brekendorf, Germany, 1995.
- [8] Poulsen, E.V.; Tabarelli de Fatis, P.: Vestas V80 – 2.0 MW Offshore Wind Turbine. In: Ente per le Nuove Tecnologie, l'Energia e l'Ambiente ENEA (Rome) (Editor): OWEMES 2000 Proceedings. Rome: ENEA, 2000, p. 239 – 244.
- [9] Stenhold, P.: Requirements for Offshore Turbines. In: Ente per le Nuove Tecnologie, l'Energia e l'Ambiente ENEA (Rome) (Editor): OWEMES 2000 Proceedings. Rome: ENEA, 2000, p. 269 – 281.
- [10] Enron Wind: 2.0 Offshore Wind Turbine – Technical Drawings. <http://www.wind.enron.com/products/20/20drawings.html>
- [11] NEG Micon: NM 2000/72 – Technical Specifications. On: <http://www.neg-micon.com/English/products/>
- [12] Frandsen, S.; Christensen, C.J.: Vindeby Offshore Wind Farm – Fatigue Loads. In: Tsipouridis, J.L.(Editor): EWEC'94 Proceedings. Volume I : Oral Sessions. Thessaloniki: EWEA, 1994, p. 397 – 401.
- [13]: The Offshore Wind Farm Working Group of the Electricity Companies and the Danish Energy Agency, Elkraft, Wind Power Department, SEAS (Editor): Action Plan for Offshore Wind Farms in Danish Waters. 1. english edition. Haslev, Denmark: 1997.
- [14] Godall, N.: Prospects for Offshore Wind Energy. In: Ente per le Nuove Tecnologie, l'Energia e l'Ambiente ENEA (Rome) (Editor): OWEMES 2000 Proceedings. Rome: ENEA, 2000, p. 321-353
- [15] Danish Wind Energy Manufacturer's Association: Offshore Wind Energy. In: [www.WINPOWER.dk](http://www.WINPOWER.dk). Homepage of the Danish wind turbine manufacturers association, <http://www.winpower.dk/offshore.html>
- [16] Juhl, H. et.al.: Cost-Effective Foundation Structures for Large Scale Offshore Wind Farms. In: Ente per le Nuove Tecnologie, l'Energia e l'Ambiente ENEA (Rome) (Editor): OWEMES 1997 Proceedings. Rome: ENEA, 1997, p. 397 – 410.
- [17] Voelund, P.; Hansen, J.: Middelgrunden 40 MW Offshore Wind Farm Near Copenhagen, Denmark, Installed Year 2000. In: Ente per le Nuove Tecnologie, l'Energia e l'Ambiente ENEA (Rome) (Editor): OWEMES 2000 Proceedings. Rome: ENEA, 2000, p. 369 – 378.
- [18] Tong, K.C.; Quarton, D.; Standing, R.: FLOAT- a floating offshore wind turbine system. In: British Wind Energy Association (London), Pitcher, K.F. (Editor): Wind Energy Conversion Proceedings of the 1993 fifteenth BWEA Wind Energy Conference. London: Mechanical Engineering Publications Ltd, 1993, p. 407 – 414.

- [19] Henderson, A. R. et al.: Floating Offshore Wind Farms- An Option?. In: Ente per le Nuove Tecnologie, l'Energia e l'Ambiente ENEA (Rome) (Editor): OWEMES 2000 Proceedings. Rome: ENEA, 2000, p . 505 - 519.
- [20] Pedersen, T.K.: Offshore Wind Power – The Operational Aspect. In: British Wind Energy Association (London), Powles, S. (Editor): Switch to Wind Power Proceedings of the 1998 twentieth BWEA Wind Energy Conference. London: Mechanical Engineering Publications Ltd, 1998, p . 277 – 281.
- [21] Denmarks second off-shore wind farm. CADDER Centre for renewable Energy ETSU, Harwell UK
- [22] Electric systems for offshore wind farms. Garrad Hassan & Partners, UK.
- [23] Role of HVDC Transmission in future energy development. John Loughran. IEEE Power Engineering Review, Febr. 2000.
- [24] Die Netzanbindung von Offshore-Windparks.P. Weißferdt, IEE Ingenieurbüro Kiel. Sonne Wind & Wärme 3/2000.
- [25] Draft of "Wind turbine grid connection and interaction". Deutsches Windenergie-Institut GmbH, Elsamproject A/S, DM Energy by order of the European Communities.
- [26] Baltic cable: Strom im Verbund. Preussen Elektra, August 1997
- [27] Role of HVDC Transmission for independent Transmission Projects. Jeffrey A. Donahue. IEEE Power Engineering Review, Febr. 2000.
- [28] Development of Power Systems. Dusan Povh, Siemens. IEEE Power Engineering Review, Febr. 2000.
- [29] Co-ordination of parallel AC-DC systems for optimum performance. Ana Diez Castro, Rickard Ellström, Ying Jiang Häfner, Christer Liljegren. International Workshop on Feasibility of HVDC Transmission networks for offshore wind farms, Stockholm, 30-31 March 2000.
- [30] Elektrische Energietechnik, Band 3, 1988, Springer Verlag Berlin, Heidelberg, New York .

## 4. Economics

Due to the limited experience with offshore wind energy use, representative data on the actual costs involved are not available. The presented work is based on literature published on the subject in the Netherlands [1], in Denmark [2] and in Germany [3], and on information provided by private companies engaged in the development of offshore wind energy projects. The data collected from these sources show considerable differences in the estimated power generation cost and in the conditions on which these estimations are based. In response to these differences the presented study expresses power generating cost in relation to site potential as a range, within which offshore wind energy costs are expected to vary, rather than a definite line.

Due to the quality of information available to the authors the detailed cost estimation for offshore wind energy use described in the following sections is restricted to the German situation. It must be noted that the absolute values cannot be transferred to other national situations as the underlying basic conditions may be different.

### 4.1 Basic Conditions of the Cost Analysis - German Case Study

Important factors of influence on the cost of offshore wind energy projects are distance to shore and water depth. These two factors have a considerable impact on the costs of grid connection and on the costs of wind turbine foundations. In order to give an impression of the water depths and distances from the shore involved, figure 4.1 shows the medium depths of water in relation to the distance from the shore in the German Bight.

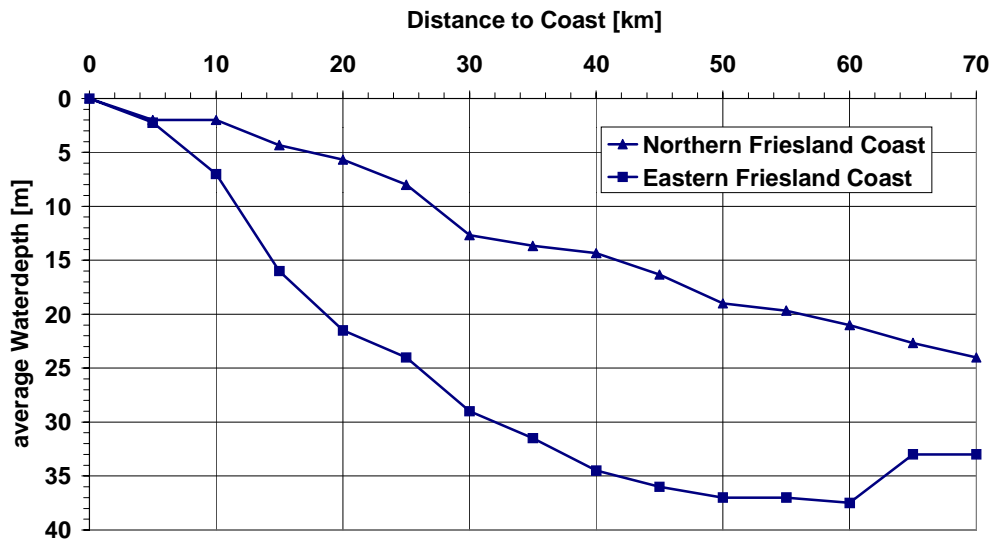

Fig. 4.1: North Sea water depths (Deutsche Bucht) [4].

The Wattenmeer National Park just off the German coastline makes exploitation of wind energy in near shore waters impossible for environmental reasons. It is therefore assumed that potential offshore wind farms will have to be located at a minimum distance of 30 km off the coast. In consequence, water depths will be between 15 and 30 m. The rise of the foundation cost as a function of water depth is depicted in figure 4.2. For depths exceeding the range shown in figure 4.2, the further course of the curve has been extrapolated in the following calculations.

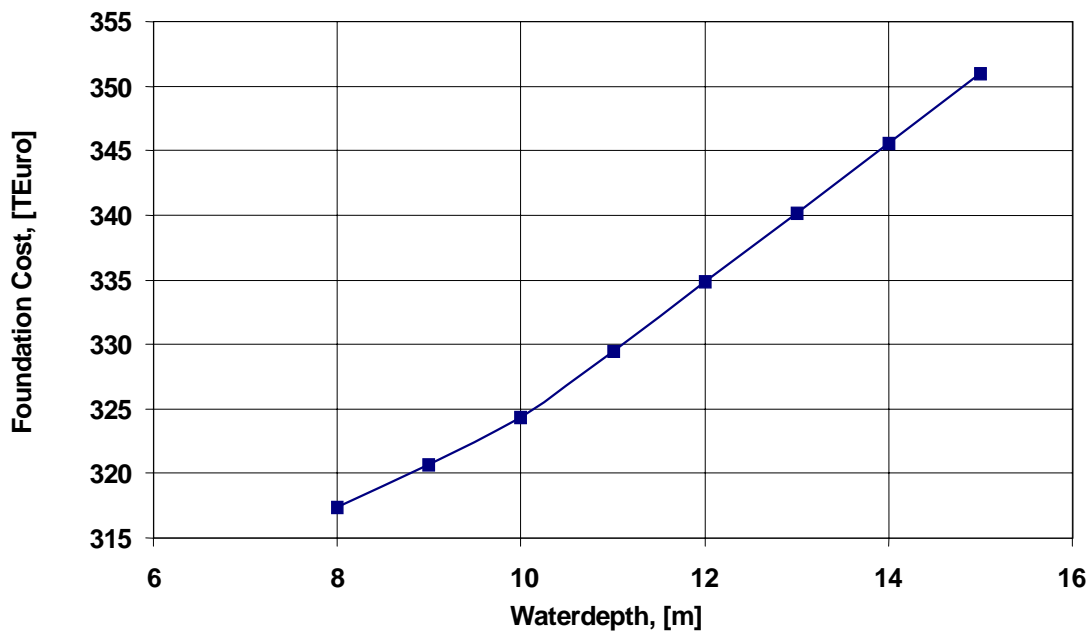

Fig. 4.2: Foundation cost in relation to water depths (turbine types 1 MW to 1.5 MW) [5].

The basic conditions which have been adopted for the cost calculations in the context of this study were defined in accordance with the recent discussion on cost of onshore wind energy use under the German Renewable Energy Law. As a starting point it may be assumed that the specific costs of offshore wind turbines are higher than for onshore turbines. Since, however, the first offshore projects in Germany are not expected to be realised within the next 2-3 years, and assuming a cost decrease for wind turbines, the calculations assume the same specific turbine cost as used in the 1999 study describing the cost situation of onshore wind energy use in Germany [6]. The same applies to the financing conditions. In order to calculate the energy yield of offshore sites, a roughness length of 0.003 m has been assumed. As accessibility to offshore structures is considerably reduced and therefore corrective maintenance may take longer to be completed as compared to onshore, the technical availability of offshore wind turbines is assumed to be lower than that of land-based machines. For park efficiency offshore, higher values can be expected due to the higher annual mean wind speed. The operating costs of offshore wind turbines are generally expected to be about one third higher than those of land-based turbines. Considering replacement investments, estimates follow the data established for the onshore situation. Despite the fact that offshore hardware is discussed above as having a longer lifetime, the following cost estimate assumes a conservative service life of 20 years; the same as for the onshore situation [6]. The basic conditions for the cost estimate are compiled in table 4.1.

WT price	869,- Euro/kW
Calculated interest rate	7.8 % (30% equit- and 70% debt)
Roughness length	0,003 m
Technical availability	95 %
Park efficiency	95 %
Operating cost	7.5 %
Price increase	2 % per year
Replacement investment	35 % of the WT price in the 2 <sup>nd</sup> decade
Service life	20 years

Tab.4.1: Basic conditions for the cost estimate.

As already explained above, an estimate of additional investment expenses depends largely on the distance of the offshore site from the coastline and thus on the water depth. In the following, additional expenses are calculated for different distances from shore. These calculations are based on offshore studies already completed [1] and [3], and on specific calculations made by private companies in the course of the planning of offshore wind energy projects. Since the

assumptions for the various additional investment expenses vary considerably, table 4.2 gives a range of costs for the most important additional expenses. The estimates show very clearly that these additional expenses depend to a large extent on the cost of the electrical connection to the grid, which again is largely influenced by the distance of the offshore sites from the coast.

Distance from shore	30 km	50 km	70 km
Foundations	35.3 % - 38.2 %	43.5 % - 51.2 %	38.8 % - 47.5 %
Installation	8.8 % - 13.3 %	10.9 % - 18.5 %	9.7 % - 23.3 %
Grid connection	31.2 % - 67.2 %	44.3 % - 82.8 %	57.2 % - 113.5 %
Other expenses	7.4 % - 23.9 %	7.4 % - 23.9 %	7.4 % - 23.9 %
Total additional expenses	82.7 % - 142.6 %	106.1 % - 176.4 %	113.1 % - 208.2 %

Tab.4.2: Additional investment expenses as a percentage of the WT price (869 Euro/kW) in relation to the distance from shore.

#### 4.2 Prognosis of Power Generation Cost - German Case Study

The following three figures show the estimated power generation costs offshore relative to distance from the coast. Three different distances, 30 km, 50 km and 70 km, are considered. Due to the varying basic conditions described under 4.1 it is not possible at present, to give a more precise estimate of power generation costs. Hence, the range within which these costs are expected to vary in relation to the site potential is expressed as an area between the two cost curves in the following figures. The breakeven point is determined assuming the average reimbursement defined by the renewable energy law with respect to offshore wind energy use. In the first 9 years WTs in the offshore sites will be granted a reimbursement of 9.1 EuroCent/kWh and afterwards of 6.1 EuroCent/kWh. The average reimbursement for 20 years lifetime is therefore 7.5 EuroCent/kWh.

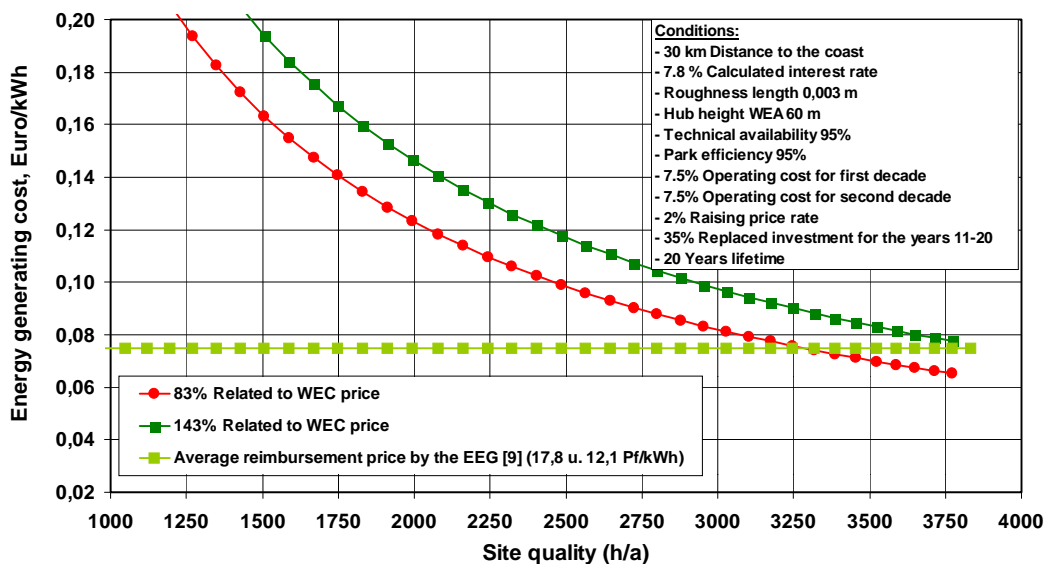

Fig. 4.3: WT power generation cost in the offshore area (North Sea) at a distance of 30 km from the shore.



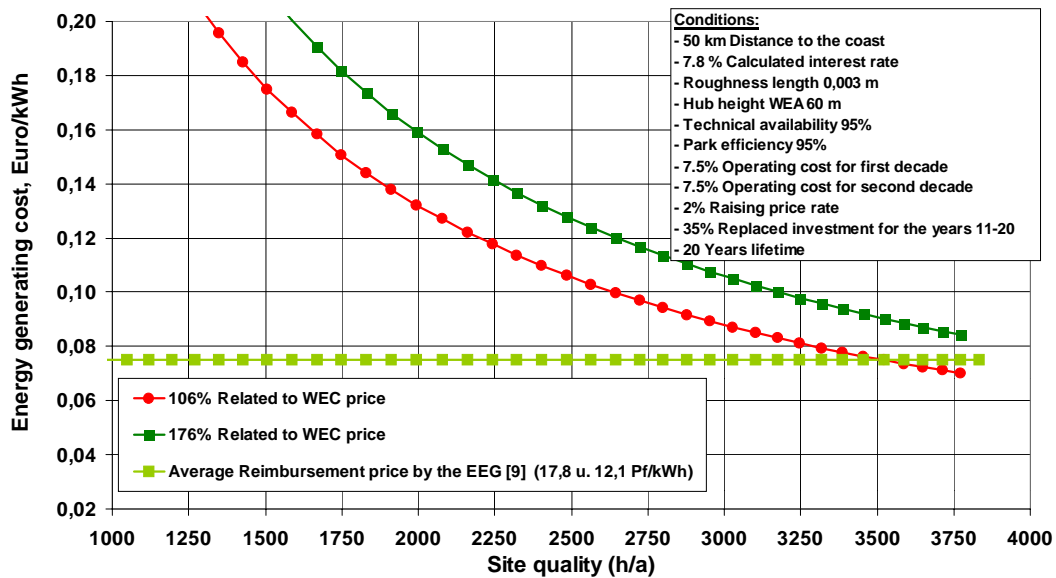

Fig. 4.4: WT power generation cost in the offshore area (North Sea) at a distance of 50 km from the shore.

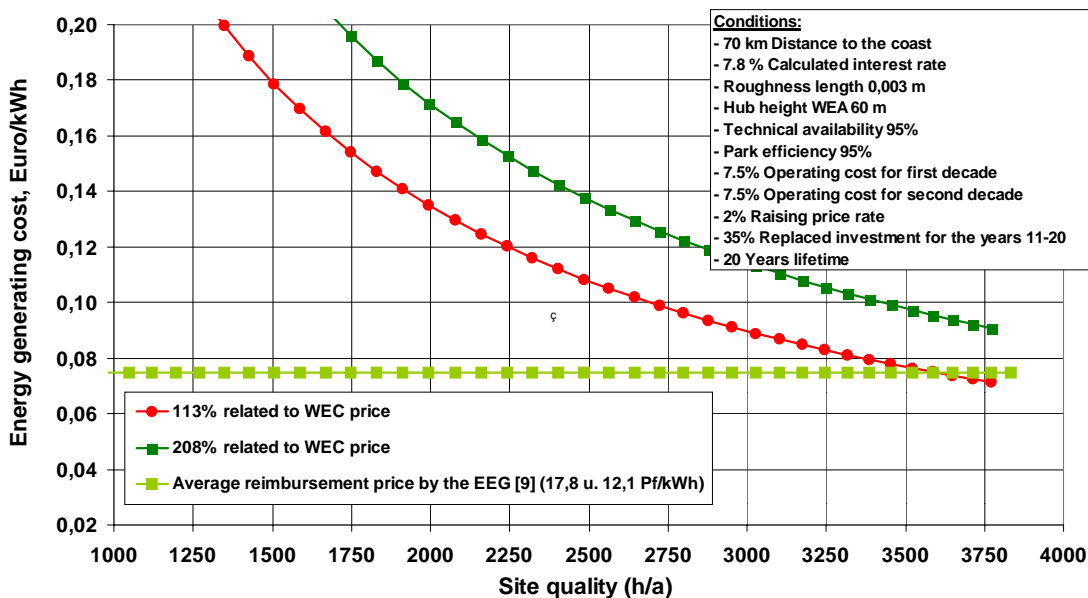

Fig. 4.5: WT power generation cost in the offshore area (North Sea) at a distance of 70 km from the shore.

The estimate of power generation cost is based on current wind turbine technology. Prototypes of 2 and 2.5 MW in size have already been built and will be available after sufficient testing onshore within the next two years for offshore application.

### 4.3 Analysis of the Results- German Case Study

Annual mean wind speeds over the North Sea lie between 7 and 10 m/s at a height of 60 m above sea level [8]. More precise data on wind potential in the German Bight are not available at present.

To be able to analyse the results, it is necessary to consider the full-load operating hours that can be achieved offshore. These considerations refer to the turbine technology already used in the estimate of the power generation cost.

Annual mean wind speed at 60m, [m/s]	7.2	7.7	8.0	8.3	8.8	9.0	9.5
Full-load operating hours	2484	2800	3020	3175	3460	3580	3830

Tab.4.3: Full-load operating hours in relative to the annual mean wind speed at a height of 60 m, based on a park efficiency of 95 % and a technical availability of 95 %. The number of full-load operating hours achieved depends largely on the turbine technology used.

Under optimum basic conditions, the breakeven point according to fig. 4.3 is achieved at 3280 full-load operating hours. Considering the turbine technology on which this estimate is based, this corresponds to an annual mean wind speed of 8.5 m/s at a height of 60 m.

Offshore wind farms located at a larger distance from land (50 km), as shown in fig. 4.4, reach the breakeven point under optimum basic conditions at sites where 3520 full-load operating hours are achieved. Considering the turbine technology on which this estimate is based, this corresponds to an annual mean wind speed of 8.9 m/s at a height of 60 m.

Offshore wind farms located at a distance of 70 km from land, as shown in fig. 4.5, reach the breakeven point under optimum basic conditions at sites where 3585 full-load operating hours are achieved. Considering the turbine technology on which this estimate is based, this corresponds to an annual mean wind speed of 9.0 m/s at a height of 60 m.

#### 4.4 Summary

In this case study on the economics of offshore wind energy use in Germany, essential basic conditions were established which are necessary for evaluating the cost situation in the offshore area. This investigation is based on the relevant literature written on this subject in the past few years, as well as information provided by private companies engaged in the development of offshore wind energy projects in Germany.

When evaluating the basic conditions for the cost estimate, considerable differences were found with regard to the expected additional investment costs that were established in relation to the distance of the offshore site from the shore. In particular, the cost assumptions concerning foundation and grid connection varied considerably. Therefore a range was established within which the power generation costs of offshore wind energy projects are expected to vary.

If a large-scale exploitation of the offshore wind energy resources is realised in Germany, in the same way as it is planned and partly realised for example in Denmark [2], we can assume a large cost reduction potential, similar to the cost development in the onshore area. In particular in the areas of grid connection, foundation and control systems, large cost reduction potentials are expected. Moreover, wind turbines will be developed for the offshore wind energy use with an installed capacity of up to 5 MW per turbine. This will lead to a considerable reduction of the specific additional investment cost compared to the cost assumed in this study, which means that in the long term the power generation cost in the offshore area will decrease noticeably.

## 4.5 References

- [1] OPTI-OWECS. M. Kühn, et al.: Institute for Wind Energy Delft University of Technology, August 1998.
- [2] Lemming, Drang Trong: Danisch Investigations and Plan of Action for Offshore Wind Power. European Seminar – Offshore Wind Energy in Mediterranean and other European Seas, OWEMES'97. La Maddalena, Italien 10.-11.04.1997
- [3] Offshore Windenergiesysteme. Fördervorhaben des BMBF Nr. 0329645, Förderträger KFA Jülich, 1995.
- [4] Schwenk, B.; Rehfeldt, K.: Untersuchungen zur Wirtschaftlichkeit von Windenergieanlagen im Offshorebereich der norddeutschen Küstenlinie. 4. Deutsche Windenergiekonferenz, Wilhelmshaven 1998.
- [5] Verband der dänischen Windkraftindustrie, Website: [www.windpower.dk](http://www.windpower.dk)
- [6] Schwenk, B.; Rehfeldt, K.: Studie zur aktuellen Kostensituation der Windenergienutzung in Deutschland. Herausg. Bundesverband Windenergie, Osnabrück 1999.
- [7] Madsen, Peter Stenvald: Tunø Knob Offshore wind farm, European Union Wind Energy Conference, Göteborg, Schweden 1996.
- [8] Mathies, H.G., et. al.: Study of Offshore Wind Energy in the EC. Herausg. Germanischer Lloyd, Garrad Hassan and Partners, Windtest KWK. Verlag Natürliche Energien, Brekendorf 1995.
- [9] Gesetz für den Vorrang Erneuerbarer Energien (Erneuerbare-Energien-Gesetz –EEG)

## 5. Environmental Impact Assessment (EIA)

### 5.1 Strategic Considerations

Among the reasons put forth in the discussion whether or not to develop offshore wind energy the expectation to minimise conflicts with respect to environment and landscape is often expressed. From experience with onshore and from first offshore and near shore wind energy projects it becomes clear that these issues have to be treated with care in order to comply with landscape and nature conservation concerns.

Every environmental impact assessment of a potential offshore wind project must recognise the strategic consideration that offshore wind brings a global and local environmental benefit by reducing fossil fuel usage and consequently carbon dioxide emissions, thereby reducing the danger of catastrophic climate change. The European Commission is presently preparing a Strategic Environmental Assessment Directive that should facilitate this process.

Prior to entering detailed consideration of environmental impact assessment (EIA) for a specific offshore wind farm, it is important to conceive the overall context: Non-renewable energy production is associated with environmental impacts beyond the actual site and date of production. Wind energy and other renewables power actually reduce these remote impacts by displacing polluting fuels.

Wind energy can contribute considerably to the national goals of CO<sub>2</sub> reduction and in fact seems to be indispensable in this respect (see sections 1 and 2). Existing research indicates that technically available off-shore wind resources exceed the total consumption of electrical power in Europe [Matthies et.al.: Study of Offshore Wind Energy in the EC, 1995]. Therefore offshore wind energy complies with the requirements for sustainability put forth in chapter 1 in that it can provide meaningful volumes of energy.

The relative dimension of offshore wind energy's environmental impact should be seen in the light of the impacts of other forms of energy supply: Further use of fossil fuels leads not only to global climatic change. Oil and gas exploration and production in the North Sea also causes pollution of water and seabed; and drilling platforms disturb migrating birds. Today there are more than 400 platforms located in the North Sea [33]. As the past has taught, the transport of oil by vessel involves the considerable risk of ship collisions and accidents with disastrous oil pollution. Connecting gas pipelines from the production sites to the sites of consumption (see europipe from Norway to Germany) often requires crossing of international conservation areas . Disregarding the possibility of a catastrophic nuclear reactor accident, the use of nuclear power is associated with impacts on the environment through contamination of exhaust air and waste water from nuclear plants and the necessity of transporting and depositing highly reactive waste.

As a further criterion to judge possible environmental impacts of offshore wind energy use the potential to minimise these impacts should be assessed.

In a strategic approach to EIA of offshore wind energy projects, it is important to assess and appreciate all of the afore-mentioned aspects. In any case a thorough assessment of the possible impacts on environment must be carried out as a part of the project planning activities. The following sections are intended to help in finding a recommended practice to do this.

### 5.2. Legal Background on EIA

The legal frame work for EIA in the area of the North Sea is given by the EIA-directive of the EC (Council Directive 85/337/EEC, amended by Council Directive 97/11/EC). This is independent of national legislation, which may go beyond the regulations of the quoted directive.

According to Annex II of the Directive, installations for the harnessing of wind energy for energy production (i.e. wind farms; 4. (a) of the Annex) require an EIA to be carried out. Even though the amendment (97/11/EC) to Article 2 says that: "Without prejudice to article 7, Member States may, in exceptional cases, exempt a specific project in whole or in part from the provisions laid down in this Directive," it is not expected owing to size and possible effects, that any offshore wind farm will be excluded from the requirement of an environmental impact assessment.

The aim of an EIA is to provide the competent authorities with relevant information to enable them to take a decision on a specific project in full knowledge of the project's likely significant impact on the environment. The assessment procedure is a fundamental instrument of environmental policy as defined in Article 130r of the Treaty and of the Fifth Community Programme of policy and action in relation to the environment and sustainable development. It is based on the principle of precaution and prevention. Environmental damage shall as a matter of priority be rectified at source and the polluter shall bear the cost of prevention and/or rectification

Further considerations have to be made if an offshore wind farm was to be planned in a Special Protection Area (SPA) under the Birds Directive or a Special Area of Conservation (SAC) under the Habitats Directive (see chapter 4.3.2 *Connecting the Wind Farm to the Grid*).

The regulations under the Habitats directive, Article 6 (2) specify: *"Member States shall take appropriate steps to avoid, in the special areas of conservation, the deterioration of natural habitats and the habitats of species as well as disturbance of the species for which the areas have been designated, in so far as such disturbance could be significant in relation to the objectives of this Directive.*

*Any plan or project not directly connected with or necessary to the management of the site but likely to have a significant effect thereon, either individually or in combination with other plans or projects, shall be subject to appropriate assessment of its implications for the site in view of the site's conservation objectives. In the light of the conclusions of the assessment of the implications for the site and subject to the provisions of paragraph 4, the competent national authorities shall agree to the plan or project only after having ascertained that it will not adversely affect the integrity of the site concerned and, if appropriate, after having obtained the opinion of the general public.*

*If, in spite of a negative assessment of the implications for the site and in the absence of alternative solutions, a plan or project must nevertheless be carried out for imperative reasons of overriding public interest, including those of social or economic nature, the Member State shall take all compensatory measures necessary to ensure that the overall coherence of Natura 2000 is protected. It shall inform the Commission of the compensatory measures adopted.*

*Where the site concerned hosts a priority natural habitat type and/or a priority species, the only considerations which may be raised are those relating to human health or public safety, to beneficial consequences of primary importance for the environment or, further to an opinion from the Commission, to other imperative reasons of overriding public interest."*

### **5.3. Extent of an EIA**

According to the EIA-Directive environmental impact has to be investigated in all phases of a specific offshore wind energy project's life-cycle. All effects associated with the wind farm at its site are to be considered. Effects to the environment may be those from the wind farm itself, its erection, the connection to the grid outside the wind farm, its operation and rebuilding after life cycle of a wind farm.

For a specific wind farm development the following phases of life cycle are to be distinguished :

- Installation of the wind farm
- Connecting the wind farm to the grid
- Normal wind farm operation
- Maintenance of the wind turbines
- Dismantling after service life

As a demonstration case the following wind farm set-up is adopted: 100 wind turbines of 2-3 MW rated power per turbine, spacing 8 rotor diameters lateral and parallel to mean wind direction, monopile foundations

Additional to the general case, special attention is given to the case of a wind farm to be built nearby or inside a protected area. That is, concerning a site under the Council directive 92/43/EEC of 21st May 1992 on the conservation of natural habitats and of wild fauna and flora (Habitats directive) respectively under the Council Directive 79/409/EEC of 2nd April 1979 on the conservation of wild birds (Birds Directive).

### 5.3.1 Possible Environmental Impact During Installation of a Wind farm

Disturbances during the construction phase to the following items must be considered:

- Structure of soil and seabed
- Water
- Benthos
- Fish
- Sea mammals
- Birds
- Archaeological sites

#### Disturbance of Soil and Sea Bed

**Description of the impact:** The bottom of the sea will be affected by building the foundations of the wind turbines. Fauna and flora will be affected through loss of habitat and coverage with sediments raised by construction activities. With a development of 100 units on the site, an area of roughly one thousand square meters will be affected assuming the diameter of a monopile foundation for a 3 MW turbine in 25m deep waters to be approximately 3.5 m. This corresponds to about 0.23% of the wind farm area. The pile diameter may be larger with increased water depth, wave loads, turbine (power) rating. It is worth noting that the size of destruction depends on the kind of foundation (see above). If gravity foundations are used the seabed will need preparation i.e. loose material will have to be taken away and possibly replaced by gravel. In addition the area covered by a single gravity base is considerably larger than that of a monopile foundation. The use of jack-up platforms gives rise to further destruction of ground on an area of some ten square meters at each site. It may be initially assumed [1], that any damage to benthos is comparable to that when extracting gravel or sand from marine sites. In addition existing pollutants may be released from sediment.

**First estimate of dimension:** The physical disturbance is spatially limited, although its magnitude and extent will depend on the nature of the construction and degree of substrate replacement involved (see above). On the other hand commercial fishery will be impossible around the installation site and probably forbidden in the area of the wind farm once it is erected. This means that beam and otter trawling will not effect the soil structure and benthic communities [28] during the time that the wind farm is in use. The monopiles themselves will cover some 0.23 % of the total area of the wind farm, although the impact area may be somewhat greater if other forms of construction are used or if substrate modification is necessary (e.g. 2.4% if scour protection measures are applied, - see also 5.3.3. *Possible Environmental Impact by Normal Wind Farm Operation*). Sediment raised through construction activities will have been carried away by water currents or will have settled some days to weeks after completion of the installation. In general the long-term physical impact on the substrate caused by piling construction may be expected to be limited to a small proportion of the total area encompassed by the wind farm. Longer term impacts resulting from changes in sediment transport/deposition and from potential mobilisation of contaminants will be more difficult to predict, but may be significant in some instances.

**Measures decreasing the impact:** Resuspension of sediments from the seabed, as well as the area physically impacted and the extent of substrate replacement, should be minimised. After completion of the construction activities, scour protection (such as artificial seaweed) should be applied if necessary.

**Need for investigation / Monitoring:** For a selected number of sites the seabed around the exact locations of the respective monopiles should be investigated before and after piling.

#### Disturbance of the Water

**Description of the impact:** Installation of foundations (piling, seabed preparation and other activities) may cloud the water around the site of construction activities and downstream of that site. Comparable effects must be expected when removing the foundations after service life. The flow of water will be influenced by the new obstacles.

**First estimate of dimension:** The effects will be limited spatially and, with respect to the clouding of the water, also in time, though some effects on current flow will persist for as long as the structures are in place. Because of the rather small extents the effects should be negligible. The influence on the sea current amounts to approximately 10% increase of flow velocity within a distance of one diameter of the structure and to 4% increase of flow velocity within a distance of two diameters [2]. See also *Disturbance of Soil and Sea bed above*.

**Measures decreasing impact:** See *Disturbance of Soil and Sea bed*

**Need for investigation / Monitoring:** In reference [2] it is concluded, that numerical simulations should be carried out to calculate the impacts on stream transport of material after installation of the wind turbines. For further references see *Disturbance of Soil and Sea bed*.

#### Disturbance of Benthos

**Description of the impact:** The impact on benthos will be twofold: loss of habitat and direct loss of individuals due to removal or coverage with soil. This will occur in the areas taken by the foundations (for a wind farm as specified in our demonstration case approximately one thousand square meters) and areas where cables are laid. Benthic fauna and flora in a wider range will be covered with mud and sand resuspended from the seabed during construction work. Their mechanisms of filtration will be obstructed. Possible turbidity of the seawater can affect growth of the macrobenthos temporarily. Coverage with soil may have a lethal effect on some macrobenthos species.

**First estimate of dimension:** Because of the relatively small extent in space and time the impact is unlikely to be problematic except in exceptionally sensitive or rare benthic environments. See also *Disturbance of Soil and Sea bed above*.

**Measures decreasing the impact:** see *Disturbance of Soil and Sea bed*.

**Need of investigation / Monitoring:** See *Disturbance of Soil and Sea bed*.

#### Disturbance of Fish

**Description of the impact:** Installation of wind turbines may disturb fish around the construction site. Such disturbance may include noise from setting up the working platform, and from piling, and vibration from working platforms or marine engines [3]. The disturbances might be higher than those from commercial fishery because of frequent and sudden changes in propeller RPM and pitch. The impact should be higher for demersal species than for pelagic ones. There might be also negative effects on less mobile stages of life cycle (eggs or larvae) through coverage with soil or direct impact.

**First estimate of dimension:** The disturbance is spatially limited and limited in time, though some activities will disturb a large area over several years.

**Measures decreasing the impact:** see *Disturbance of Sea Birds*

**Need for investigation / Monitoring:** reference [2] investigates the question of whether fish will be disturbed by water turbidity, presence of vessels and piling noise are noted as important. An inventory of existing species by a sampling program may be set up before the start of

construction work and compared with a sampling sequence after completion of the construction work.

#### Disturbance of Sea Mammals

**Description of the impact:** It is assumed that small whales and seals could be affected by noises from machines and vessels, piling and installation of the wind turbines. Piling, in particular using hydraulic hammers creates high frequency noise with considerable sound power levels on the instant of impact.

**First estimate of dimension:** From the limited evidence presently available all that can be concluded is that potential wind turbine developments in areas of particular importance for cetaceans and seals need to be approached with care.

**Measures decreasing the impact:** The time for erecting a wind turbine should be reduced and movements of vessels minimised.

**Need for investigation / Monitoring:** If there are different techniques available for installation of foundations and wind turbines, their effect on sea mammals should be compared to minimize the impairment. Currently only little knowledge about the effects of different noises to sea mammals are available. Installations of the first offshore wind farms should be used to investigate open questions in more depth. See also *Disturbance of Sea Birds*

#### Disturbance of Sea Birds

**Description of the impact:** Disturbance to birds can occur during the construction phase when cranes and vessels or construction platforms (jack-ups) are present in the area, piles are rammed, wind turbines are installed and cables are laid. The construction will take place during the summer season (May to end of August) and may last several years, depending on the size of the actual wind farm. It further depends on the building capacity of the construction companies and on the size of the disturbed area. In the case of four construction teams continuously on site throughout the building season there will be an area of approximately three km<sup>2</sup> temporarily unsuitable for birds because of disturbances. This assumes that an area of at least 500 m around the site is disturbed.

**First estimate of dimension:** According to [4], within areas suitable for wind energy use densities between 0.1 and 42 birds/km<sup>2</sup> of pelagic species are to be expected in the summer period. So, for sites where these densities apply, the numbers of birds temporarily displaced by construction activities are not considerable, even if it is assumed that all birds within a radius of 500 m are displaced by construction activities. (See also [5])

**Measures decreasing the impact:** The time for erecting a wind turbine should be reduced and movements of vessels minimised.

**Need for investigation / Monitoring:** If there are different techniques available for installation of foundations and wind turbines, their effect on birds should be compared to minimize the impairment to birds.



## Destroying of Marine Archaeological Sites and Items

**Description of the impact:** There is a considerable density of wrecks on a number of reefs in Danish waters for example [6] and there may be a similarly high density of stone age settlements in a number of the shallow areas which have become submerged since the ice age. A wind farm development at such sites would destroy archaeological items.

**First estimate of dimension:** No information available.

**Measures decreasing the impact:** The area of working should be minimised in the neighbourhood of archaeologically interesting sites. If archeological artifacts should be found, investigations and measurements of the sites should be done.

**Need of investigation / Monitoring:** Searching for marine archeological goods prior to development of a specific site could certainly help to avoid such sites.

### 5.3.2. Possible Environmental Impact Due to Connecting the Wind Farm to the Grid

**Description of the impact:** A cable has to be laid between the wind farm and the grid. It is assumed that the cable will be laid approximately one metre beneath the seabed. For this a small trench has to be cut by water jet or plow or must be dug. In the case of Horns Rev (Denmark) it is supposed that this work requires two working days [6]. Laying of the cable may disturb a two meter wide sector on the ground on both sides, and water will be troubled some meters around the site of construction. The effect on water will be diminished after some hours, the effects on the sea floor for some weeks. In the offshore environment this impact might be considered negligible in most cases (exception: possible pollutants being resuspended).

Although the site of a wind farm itself may be outside nature conservation areas, from many suitable offshore sites in the North Sea the way to the grid will have to cut through the Wadden Sea with its sensitive aquatic, semiaquatic and land habitats. These habitats are nature conservation areas under the EC Habitats Directive and the EC Birds Directive in Denmark, the Netherlands and Germany. The impact on these habitats may be significant. In the case of crossing such designated habitats the offshore project has to be examined additionally according to Article 6 of the Habitat Directive (see section 5.2).

Onshore, further investigations on environmental impact may become necessary, e.g. if new electric power lines have to be built. In this context the roosting grounds for geese in the Dollart region on the Dutch/German border may serve as an example. However, the authors of [5] come to the conclusion that environmental impact from grid connection is negligible. In [7] it is concluded that any loss of area creates a significant disturbance.

**First estimate of dimension:** It is not possible to make generalised conclusions about the possible impacts of grid connection of offshore wind farms across Special Areas of Conservation (SAC) under the Habitats directive or other designated environmental protection areas.

It will be case-dependent whether grid connection of offshore wind farms across a SAC will be rated as a significant disturbance or deterioration of habitats or species and whether electricity supply by means of offshore wind farms represents an imperative reason overriding public interest in the sense of the Habitats directive. Therefore grid connection across the Wadden Sea for example could create a (legal) problem, as has happened in the case of the Europe gas pipeline across the Wadden Sea of Lower Saxony, Germany.

**Measures decreasing the impact:** To minimize impact from grid connection, cable routes should be selected outside of SAC's or SPA's and especially outside of priority habitats or species (see Annex I and II respectively of the Habitats Directive). The number of cables should be kept to a minimum.

If no grid connections are available outside SAC's and permission, under the special conditions in article 6 of the Habitats Directive, is given to cross a SAC. The dimension of grid connection should be large enough to link further wind farms to the grid, as far as such are planned or probable. Further on it could be advantageous to create an offshore grid collecting all electricity

from wind farms in a region and to have this offshore grid connected to the onshore grid through a single cable which should use existing infrastructure.

As a technical solution a three phases cable is preferable to minimize the effects from magnetic fields of the cables or a bipolar cable in case of HVDC.

**Need for investigation:** At an early stage of planning an offshore wind farm, a route for grid connection outside of SAC's should be sought. Large wind farms will require large grid capacities so that only a few connection points will be suitable, probably further away from the coast with the need of further cabling onshore. From this point of view it is important to have thorough planning for grid connections of large offshore wind energy developments carried out at an early stage. Such strategic planning will avoid bottle-neck situations which could possibly make grid connection of the offshore wind farm impossible. It should further be investigated as to whether if existing over-sea cables can be used or upgraded for grid connection of offshore wind farms to minimize negative impacts from laying cables.

### 5.3.3. Possible Environmental Impact by Normal Wind Farm Operation

In normal operation the following impacts on the environment may occur:

- Disturbance of water
- Disturbance of the seabed
- Poisoning of the ecosystem by material
- Impact by electric fields and heat generated from the cable links
- Disturbance of benthos, fish and sea mammals
- Collisions of birds on the turbines
- Wind turbines as barriers
- Ousting birds off their traditional feeding grounds
- Impact on landscape

#### Disturbance of Water

**Description of the impact:** Water flow will be influenced by the new obstacles. During maintenance events, presence of vessels and maintenance activities create disturbance in the area. It is expected that maintenance frequency will be seasonably dependent. Most of preventive maintenance will probably be carried out in the period from May to September.

**First estimate of dimension:** The influence on water flow around the foundations amounts to only 10% at a distance of one diameter from the structure and 4% at a distance of two diameters [2]. See also "Disturbance of Sea Bed".

**Measures decreasing the impact:** see "disturbance of seabed"

**Need for Investigation:** No need recognizable.

#### Disturbance of Sea Bed

**Description of the impact:** Loss of habitat takes place where the foundation members cover or penetrate the seabed. These dimensions vary with respect to the foundation type used. In case of monopile foundations habitat loss will be equivalent to the area covered by the sum of the piles' cross-sections (see Disturbance of Soil and Seabed in section on installation of wind farms).

To reduce scour around the monopile the area in the vicinity of the pile may have to be covered with a radius of approximately 10m by gravel, mattress or artificial seaweed. Further changes may appear in areas with stronger currents. Components of the sea bed could be shifted in a limited vicinity of the foundations depending on sea currents.

**First estimate of dimension:** The disturbance of the sea bed is spatially restricted to a relatively small proportion of the total area covered by the windfarm. Although [5] suggests that wind turbines cause negligible reductions in the composition of substrate, the extent of such reductions will actually be dependent on the type of construction, substrate modification and anti-scour protection used in any one case.

**Measures decreasing the impact:** If it is necessary to protect the area around the pile against scour, the area covered will amount to 2.4% of the wind farm area.

**Need for investigation / Monitoring:** In the course of an environmental monitoring program, structure and composition of soil in the surroundings of selected monopiles should be observed.

### Contamination of the Environment by Materials

**Description of the impact:** According to [5] the assumption is adopted, that no chemicals against fouling will be used. They would have negative effects on life not only near the piles but also in the downstream surroundings. There is a risk leakage of lubricant or fuels or cooling agents from gear boxes and transformer units or abrasive material due to friction in special turbine components like slip ring systems. However, it is expected that no poisonous and as far as possible biodegradable fuels and agents will be used and that proper precautions to avoid leakages and for collecting any abrasive material are taken.

Further problems might arise from  $MgCO_3$  deposition at the electrode rings of a monopolar systems.

**First estimate of dimension:** The probability of pollution due to leakages cannot exactly be determined and will be dependent on the machine design. However, it can be noted that the filling amounts in the components containing lubrication fuels and cooling agents are comparably small: some tens of liters for gear boxes and smaller transformer units and a few hundred liters for larger transformer units.

It is unknown whether  $MgCO_3$  deposition has any negative effect on the environment or on the ecosystem.

**Measures decreasing the impact:** The best measures to avoid spill of oil and other operating fuels are proper durable design of sealings and preventive maintenance.

With respect to sea cables the use of bipolar cables would cause the lowest effects because electric fields can be kept small and no electrode rings giving rise to  $MgCO_3$  deposition would be needed.

**Need of investigation:** The reaction of fish and invertebrates to  $MgCO_3$  deposition should be investigated.

### Impact by Electric Fields and Heat Generated from the Cable Links

**Description of the impact:** Depending on the type of cables laid between offshore wind farms and the grid on the mainland, electric and magnetic fields will be created in the vicinity of the cable. These fields might disturb fish and sea mammals that navigate by means of the magnetic field of the earth. There could be an influence on navigation and migration movements or an impediment to searching for food. To date no in depth research on these impacts is available.

An extreme example of the generation of magnetic fields is the HVDC "Baltic cable" between Sweden and Germany. It uses a monopolar transmission technique and has a capacity of 600 MW, which creates a current of 1330 A. The magnetism of the cable in a distance of 6 m corresponds in intensity to the natural geomagnetism in the Baltic sea, which is about 50 Microtesla [8]. At the surface of the water directly above the cable magnetic compasses show

considerable deviations forcing ship traffic to be informed about the cable to avoid wrong navigation.

**First estimate of dimension:** It is unknown at present whether, and to what extent, the various species will be disturbed. A study [5] suggests that the negative effects are negligible, provided that state-of-the-art technology and best practice are applied. Heating effects should not play any role if cables are buried in the seabed at a suitable depth.

**Measures decreasing the impact:** For bipolar HVDC and for A.C. transmission the generation of magnetic fields will be much smaller due to the compensation effect of the go-and-return line. In theory two lines with opposite currents will emit no magnetic field, if they are laid parallel and close to each other. The value of the magnetic field is influenced by the distance between the go-and-return line. Thus a three-conductor cable will give advantages compared to three single conductor cables. However, to date the transmission capacity of three conductor cables is less than that of single conductor cables. In order to ensure that state of the art technology and best practice are applied, only 3-phase A.C. or bipolar HVDC links should be used to minimize electric and magnetic fields on the sea floor.

**Need for investigation / Monitoring:** In the course of a "Before-After-Impact-Study" the influence of magnetic fields from the cables should be investigated. Also further experimental work should be done on this question in the frame of research activities. Detailed methodical indications are given in [2].

#### Disturbance on Benthos

**Description of the impact:** In areas with slow water current in a zone around the monopiles the embossment of the sea floor and the structure of sediments will change. It depends on the situation at the individual site whether this will happen or not. However, applying the principle of precaution the possibility will be taken into account. The foundation itself may represent a fundamentally different surface from the natural substrate and impact on species diversity. As benthic communities that prefer hard substrate habitats are considered not typical for many regions of the North Sea, their colonisation may result in adverse impacts at ecosystem level. Furthermore, as wind farms will be excluded from commercial fishery, beam and otter trawling will not affect the soil structure and the macrobenthos community during the time the wind farm is in use.

**First estimate of dimension:** The extent of disturbance will probably be limited to a small area relative to the total area covered by the wind farm and will not make living and settling of all animals impossible. Predicting long term changes to community structure will, however, be very difficult.

**Measures decreasing the impact:** Monopiles should be as small as possible in order to minimize loss of "natural" habitat. With respect to preserving the typical benthos and ground structures there should be as few as possible additional hard substrates in the vicinity.

**Need for investigation / Monitoring:** The colonization of monopiles and of the surrounding of the foundations and the changes in species diversity should be observed for a representative selection of monopiles before and after placing the foundations.

#### Disturbance of Fish

**Description of the impact:** Fish may be disturbed by noise, by vibration and possibly by the moving rotor blades, especially through light effects and shadow from the blades. Wind turbines will emit airborne noise as well as through the support structure directly into the water. While frequency spectra of the noise emissions are well known in the case of airborne noise, or may be measured in the case of structural noise, it is not clear what frequencies can be perceived by fish. Further there could be effects on the turbidity of flowing water in the surroundings of the wind turbines. Other electrosensitive species could be disturbed by electric cables or their magnetic fields. Migrating and orientation of those species could be affected by the cables. During the maintenance season (May to September) maintenance vessels could disturb fish populations between the wind turbines.

On the other hand commercial fishery should be forbidden in the area of the wind farm.

**First estimate of dimension:** It may be assumed that no fishing activities are to take place within the wind farm once it is operating. Apart from that there will be a safety zone of 500 meter around the farm.

Due to the fact that it is not known to what kind of noise and to which frequencies fish are sensitive the extent of disturbance cannot be estimated at this time. It is suggested [5], that the dimensions of maintenance shipping are comparable to those from fishery, therefore there is no further effect on fish.

**Measures decreasing the impact:** Offshore wind farms should be sited outside important areas for fish. Noise and vibrations should be minimized in any case. Cables should be used that create no or only a minimum of magnetic fields or heat production.

**Need for investigation / Monitoring:** [5] concludes in their EIA, that no further comments about kind and dimension of noise from wind turbines can be made at present. Reference [2] recommends that investigations concentrate on demersal fish species because the dimensions of investigation on pelagic species would render them disproportional. Changes in number and composition of species should be investigated. Furthermore the interaction between food supply, noises and fishery impact should be investigated.

After installation of the first offshore wind farms, noise and vibrations from wind turbines should be measured and the behaviour of fish should be observed. The population of fish should be examined prior to and after wind farm installation in a suitable monitoring program. The actual influence of artificial magnetic fields on migrating and orientation of fish should be investigated.

#### Disturbance of Mammals

**Description of the impact:** Operation and maintenance of the wind farm can cause several effects on marine mammals. Sound power level for 1MW offshore machines will be around 103dB and for multi-megawatt machines some 106dB are expected; however it is anticipated that there is no noise transmission from air to below water. Airborne noise transmission over large distances over open sea is more likely to be an issue. Little is known on how the visual effect or noise produced by wind turbines will influence seals. Investigations near to the shore have shown no negative effects from wind turbines to common and grey seals [2]. For instance in the vicinity of the wind farm Tunø Knob regularly a group of 10 seals haul out.

Information on how dolphins and whales are influenced by offshore construction work, and by operational maintenance of wind turbines at sea is lacking. Dolphins and whales (but also seals) might be influenced by the vibrations/noise of the wind turbines being directly transmitted into the water. While frequency spectra of the noise emissions are well known in the case of airborne noise or may be measured in the case of structural noise it is not clear what frequencies can be perceived by sea mammals.

**First estimate of dimension:** The behaviour of cetaceans in response to offshore wind farms is totally unknown, but what is known of impacts on common seals (*Phocoena vitula*) and grey seals (*Halichorurus grypus*) seems to indicate that they are not significantly disturbed by the presence of offshore wind turbines [2].

**Measures decreasing the impact:** The best method to avoid impact on sea mammals is to choose a site of little or no importance for this group of animals, (i.e. avoiding such areas as breeding places or haul out sites of seals). Further steps are to reduce vibrations and noise from the monopiles and to minimize magnetic field around the cables.

A precaution approach should be taken when potentially vulnerable and important areas for seals are nearby. The presence of colonies (rest/nursing places) may be used as an indication of the importance of the area.

**Need for investigation / Monitoring:** The behaviour of different species of sea mammals in response to noise and vibrations from different types of wind turbines should be observed. Scientific investigations in the North Sea should be concentrated on the Porpoise (*Phocoena*

*phocoena*) [2], due to its status in Annex II of the Habitats Directive. Reference [2] gives methodical indications.

## Disturbance of Birds

As there exists by now some significant data regarding the impact of wind turbines on birds and as this impact is a point of significant interest it shall be described in more detail.

## Collision of Birds with the Turbines

**Description of the impact:** Birds may be killed or injured by collisions with wind turbines. This may occur mainly in bad weather conditions like rain or storm associated with unfavourable visual conditions. Collisions of birds with wind turbines in onshore wind farms is in most cases only a minor problem. However, it is unknown yet whether this applies to the offshore situation as well.

Further loss of seabirds might arise by collision when moving in short distances between feeding and roosting grounds or between feeding grounds and breeding sites [16]. However, at the moment there are no comprehensive and little quantitative results available about the collision risk of birds at offshore or near shore wind farms.

On the other hand in [9] it is reported, that birds are able to avoid other obstacles like electric power lines and investigations on the offshore wind farm Tunø Knob have shown that Eiders actively avoid the vicinity of the wind farm in their flight movements. Such behaviour reduces the risk of collision, at least for those birds which are familiar with the vicinity of the wind farm [15].

**First estimate of dimension:** The main risk for birds migrating at low altitudes will arise in situations with unfavourable visibility conditions (dark, fog etc.). The collision impact on birds are spatially limited to the wind turbines themselves but may be a function of the physical dimensions of the wind farm as a whole. The disturbance of birds may be variable in time subject to feeding and migrating pattern. First approaches to a qualitative estimation of the collision risk [13,14] suffer from lack of suitable information.

This risk off near-shore wind farms on breeding birds migrating between breeding sites onshore (at the coast) and foraging sites is estimated as small [5]. However, not only the number of birds lost but also the question of which species are concerned shall be considered. For very rare species even small numbers of losses may represent a severe impact.

**Measures decreasing the impact:** Variations in the spatial distribution, density of wind turbines per unit area and hence the absolute physical dimensions of the individual wind farms may be of importance when seeking a way to minimize the collision impact. In [5] one large wind farm is preferred to two smaller ones with the same overall capacity. According to [14] it is suggested, that large wind turbines minimize the number of bird collisions as opposed to smaller wind turbines. Another measure recommended in [15] is to have the wind turbines painted in a light colour for better visibility. This of course is in contrast to the demand from landscape protection, where grey colours are preferred to be less visible for human eyes. It is not clear whether wind turbines should be illuminated for reason of bird protection because illuminated structures in the North Sea could attract birds and hence create an adverse effect with increased collision victims.

With stationary birds becoming familiar with the surroundings and obstacles, the collision risk for this group of birds is smaller than for migrating birds passing through. In any case it is worthwhile to make the turbines as visible as possible (light colour). Reference [5] concludes that intensity of bird migration declines with distance from the coast. Therefore the collision risk at wind farms in near shore waters is greater than for installations far offshore.

**Need for investigation:** To arrive at accurate estimates of potential numbers of victims determination of collision risk in various light conditions is necessary. A fundamental issue to be investigated is the distribution of bird migration activity over height above sea level. The priority should be to investigate bird migration at heights of up to 300 m. For methodical investigations see [2]. As also concluded in [5], there is a major gap in knowledge about the influence of offshore wind farms on birds and no investigations about the collision risks. There exist reports on apparently rare events with rather large numbers of bird victims from collision with single

obstacles like radio masts and offshore platforms [10,11,12]. It should be further investigated what special conditions led to these events and whether these circumstances apply to offshore wind farms as well.

### Wind Turbines as Barriers

**Description of the impact:** Nearly 65 Million birds (excluding seabirds) cross the North Sea every year in a broad front line [31]. The height of migration is lower than on the mainland, therefore a considerable share will touch the zone of the wind turbines (height: 100 – 150 m), though behaviour of migration changes with weather conditions, wind direction and species. Wind farms may be a barrier for birds on their long distance migration or on their flight from feeding grounds to sleeping grounds or from feeding grounds to breeding sites. This barrier may lead to more or less long detours or to giving up sleeping or feeding sites.

Meanwhile first experience from Danish and Swedish [32] offshore wind farms are available. Common Eider and Common Scoters have been found to avoid the Tunø Knob wind farm up to a distance of 1500 m [15]: "... the area with reduced flight activity not only concerned the wind farm itself (800 x 400 m), but also a larger area surrounding it (in total 3400 x 3800 m)." In this case the area of the wind farm itself and beyond it surroundings of at least 500m have become unsuitable for roosting birds. The number of birds being displaced depends on the specific site and on the specific distribution of birds as the population of birds is most probably not evenly distributed but accumulated in some areas, depending on season and food supply. Also the specific behaviour of the individual species will have an influence on the size of the affected area around the turbines. Eiders actively avoid the vicinity of the wind farm in their flight movements. This further decreases the risk of collision (see above).

*"Eiders showed nocturnal flight activity, both in situations with and without turbines (control area). Most flights were relatively short (max. 1 km) and occurred within the feeding area and between feeding and roosting areas. Flight activity occurred throughout the night and the intensity was predominantly determined by (moon)light conditions. In the absence of moonlight, flight activity was lower than during twilight. When the moon was out, nocturnal flight activity was 3-6 times as high as in night situations without moon, and comparable to the activity during dusk. During calm weather, massive movements over large distances took place at dawn, resulting in large congregations of displaying Eiders. Mist and strong wind reduced the intensity of these morning flights. During dusk and at night, flight activity in the vicinity of the wind farm was lower than away from the wind farm. This effect was noticeable up to distance of 1000 - 1500 m from the nearest turbine and increased in strength closer to the wind farm. The effect was strongest in moonlit nights, small during dusk and non-existent during dawn. We tentatively interpret these effects to be the result of active avoidance by the Eiders, rather than a passive reflection of feeding distribution.*

*Within the wind farm sector (wind farm plus the area up to 500 m outside the wind farm) more groups of Eiders flew along the outside of the wind farm than through the wind farm compared to expectations based on the wind farm's dimensions. Groups approaching perpendicular to the longitudinal axis of the wind farm crossed the wind farm less often than groups approaching the wind farm parallel to the length axis. Although circumstances for birds approaching from both directions differed, this seems to indicate that Eiders prefer to fly through an opening of 400 m rather than one of 200 m. The proportion of groups flying through the wind farm was similar under different light conditions. Seven percent of all movements changed track when approaching the wind farm. Most changes of track occurred under light conditions.*

*Common Scoters were also nocturnally active. Their movements concerned short displacements within the feeding area. Nocturnal flight activity was more intensive under moonlit conditions than under dark conditions. In these aspects common Scoters resembled the Eiders."* [quoted from 15]

The results seem to be in line with earlier comparable studies on land and in fresh waters and show that even species that are not used to finding obstacles in their flight path in their natural habitat actively avoid wind turbines.

Both Eiders and Common Scoters are nocturnally active, but in dark periods, flight intensity is far less than in moonlit periods. The total number of collision victims is determined by the product of

flight intensity and the probability of collision. We know that flight intensity under dark conditions is lower than in moonlit situations, but have no information on how collision risk is influenced by light conditions at open sea. This means that lower flight intensity in dark nights relatively reduces the probability of collision.

#### **Measures decreasing the impact:**

*“In decisions on wind farms in the North Sea actual recommendations are:*

*Since local familiar birds, such as wintering sea ducks are probably familiar with obstacles in their area, the collision risk for this group is smaller than for groups that only pass occasionally. In any case it is recommendable to make the turbines as visible as possible (light colour).*

*Whether or not Eiders will fly in between turbines, fly around them or choose a different feeding or roosting area altogether, will be determined by a number of factors: the size of the corridor, the length of a possible detour and the availability of alternative feeding and roosting areas. To take the flight routes of sea ducks into account, measures should be taken to enable them to follow their route with a small detour. Gaps in the arrangements of turbines can act as corridors. Based on the results of this study, these corridors need to be several kilometers wide in order to be effective.*

*From the birds' point of view long line-shaped arrangements perpendicular to the main flight direction must be avoided as these can cut off or deteriorate flight routes or make areas inaccessible.*

*As it is difficult to predict whether and in what manner sea ducks will fly through large wind farms, it is preferable to keep the distance between turbines small and by doing so minimize the total surface area of the wind farm.*

*in the trade-off of Eiders to fly outside or through the wind farm or leave the area and go to a different feeding/roosting area altogether different factors are important: the size of the gap between turbines, the length of the detour and the availability of alternative feeding/roosting areas. To take sea ducks and other birds that fly between their feeding and roosting areas into consideration, possibilities should be created for them to follow their route with as short a detour as possible. Corridors can be created by leaving large gaps between turbine formations. Based on our results the size of these spaces must be several kilometers.*

*Long continuous formations perpendicular to the general flight direction of ducks must be avoided, since possibly flight routes are cut off or become unattractive. In the worst case areas can become unsuitable.” [quote from 15]*

**Need for investigation / Monitoring:** The actual effects of offshore wind farms on migrating birds should be investigated by means of a “Before-After-Impact-Study”.

#### **Ousting Birds off Their Traditional Feeding or Roosting Grounds**

**Description of the impact:** As reference [4], [29] and [30] describe, several large areas of the North Sea are important as roosting and feeding sites for sea ducks, divers and other pelagic birds. Most of these areas have not yet been marked as Special Protection Areas under the EC Birds Directive. Very important examples inside of the area covered by this study are “Moray Firth – Aberdeen Bank – Tees”, “Skagerrak – Southwest Norwegian Trench” and “Eastern German Bight” and “Cap Gris – Schiermonnikoog”, as the only winter resorts in the North Sea for Red- and Black-throated Divers (species on Annex I of the Birds Directive). The distribution of the birds' populations is not continuous but patched. Places of concentration are in areas with ample food supply. Furthermore fishing activities influence the presence of seabirds [35]. From onshore wind farms it is well known that birds avoid the vicinity of wind turbines. They may be disturbed by noise or shadow from the blades and hence more or less large areas around wind farms will be avoided. Investigations in onshore wind farms have reported such behaviour [16, 17, 18, 19, 20, 13]). This behaviour differs from species to species and also depends on the individual bird itself as the distance maintained to the wind farm is longer if the birds are roosting or sleeping than if the birds are feeding .



The behaviour of avoidance has been verified for a large number of species at onshore wind farms (see above). Little experience is available for the offshore situation.

During the construction of the wind farm Tunø Knob a "Before&After Impact Study" was carried out [21]. It was found that there was no decline of the Eider population as compared to that in the control area.

Three further experiments were carried out after erection of the turbines[21]:

1. First decoys were placed in the vicinity of the turbines and the response of flying and landing birds to these decoys was observed. At a distance of 100 m to the turbines flight activity was less than at distances of 300 and 500 m off the turbines.
2. In a second experiment during which the turbines were switched on and off, no effect on the distribution of the ducks was found for the rotor movement and operating sounds. In the last experiment, the availability of food and its exploitation by the Eiders was studied throughout a complete winter in four areas at varying distances off the turbines. Most of the variation in the numbers of Eiders present in the observed areas was found to be linked to the local food situation. The authors concluded that the turbines had no effect on the food exploitation in the vicinity of the wind farm during an entire winter.

Other species were not present at Tunø Knob in a relevant number so there is a gap of knowledge with respect to other species. Cormorants were never spotted using the foundations of the turbines as a roosting places, however, considering the large amount of Cormorant faeces found on the foundations they must have been used at some time. Herring Gulls and a few Great Black-backed Gulls, with a maximum of 194 individuals, were mainly seen in the proximity of Eiders. Though there is only little experience about the behaviour of seabirds around wind turbines, it may well be suggested that they show similar avoidance behaviour as other sensitive species near onshore wind farms [17, 20]. Working platforms may be roosting places or look-outs for feeding birds such as Shags or Cormorants. Platforms for oil and gas production attract birds, as all common species are feeding on the garbage from the platforms [27]. No further information is available about the function and the extent of use of platforms as roosting places. The exclusion of fishery and its impact on available fishstock within the wind farms could attract fishing birds.

**First estimate of dimension:** Useful quantitative knowledge about birds avoiding offshore wind farms is not available. Only for two species are first experiences under untypical conditions available. Therefore the true effects from large offshore wind farms, covering areas of some tens to hundreds of square kilometers, are not clear.

**Measures decreasing the impact:** Nevertheless, some general conclusions to reduce negative effects on birds can be drawn:

Despite the fact that the locations of shellfish beds can vary from year to year, it is possible to take the location of favourable feeding areas into account by placing the turbines in waters as deep as possible.

Recommendations for the near shore wind farm (according to [15]):

*"The results are important in decision making on wind farms in the North Sea, although in every new situation a detailed study is needed to be able to apply the results from this study in Denmark. Knowledge on local flight patterns during the night and on the location of roosting and feeding areas of sea ducks is essential to evaluate and minimalise risks.*

*Based on results presented, the following recommendations are made for decision making on wind farms in the North Sea:*

*Although locations of shellfish can vary from year to year, the distribution of favourable feeding areas can be taken into account by placing the turbines in the deepest water possible.*

*Since it is hard to predict whether sea ducks will fly through large wind farms we recommend that the surface area of the total wind farm is kept as small as possible. Therefore the distance between turbines within clusters should be minimized."*

The reduced flight activity in the vicinity of the wind farm and the low number of flight movements through the wind farm indicate that wind farms can act as flight path barriers. This effect is probably related to the size of the wind farm. Whether or not this effect creates a problem in reaching favourable feeding and roosting areas depends on the size and the local situation of the wind farm relative to roosting and feeding sites. In this respect especially long, line-shaped wind farms create a higher risk of disturbance.

Also the configuration of the wind farm may influence birds. Reference [15] concludes, that dense clusters with gaps between them should be the best configuration. [5] suggests, that illumination of wind turbines would be contra productive because of attracting migrating birds. According to [14] the risk of collision is smaller with two-blade rotors than with three-blade rotors.

It would be best if the wind farm was sited as far as possible from the coast because there is a gradient from coast to the open sea with declining numbers of birds. Sites in deep waters should be better in this case than sites in shallow waters [5].

**Need for investigation:** There is no further experience available on the impact of offshore wind turbines on birds [9], [15]. Signal lights at the wind farm are considered to be suitable to make clear the obstacles. Signal lights may have the same effect on birds, but it may attract birds, too.

The boundaries of Important Bird Areas (IBA) are not yet well defined. Therefore further investigations about the distribution of pelagic birds may lead to a shift of IBA-borders (see [6], p. 101-103)

### Impact on Landscape

**Description of the impact:** Offshore wind farms will influence perception of landscape in a fundamental manner, because atypical vertical and moving structures are introduced into otherwise calm and monotone views. Most of the wind turbine designs will have three blades, but also two blades are an option that may give an impression of uneasiness depending on the viewers predisposition. Distances between turbines in an offshore wind farm are relatively larger than on shore. Anticipated offshore spacing will feature distances of 8 –10 rotor diameters between the individual wind turbines.

**First estimate of dimension:** It should be noted that impact on the landscape is an entirely subjective matter. Some viewers regard wind turbines as attractive, others take the reverse stand-point. Obviously it's very difficult to find an appropriate scale to estimate the impact's dimension as it strongly depends on the personal taste of the viewer. However, several attempts have been made to visualize the impact with computer graphics and animations. However, it has turned out to be difficult to obtain realistic images due to technical constraints. Beside the pure size of a wind turbine, the impression of regularity of the wind turbines' arrangement in the entire wind farm was found to be of importance and dependent on the viewing angle [1].

**Measures decreasing the impact:** The visibility of wind farms may be reduced by choosing navy camouflage colours similar to the grey sky or sea, though it should be noted that wind turbines become invisible at a distance of some 45 km from the coast due to curvature of the earth's surface.

**Need of investigation:** For public discussion the question should be answered for how many days offshore wind farms are visible assuming prevailing weather conditions (see also [24]).

#### 5.3.4. Possible Environmental Impact During Dismantling of the Wind Turbines

**Description of the impact:** The foundations of the monopiles must be terminated at least three meters beneath the ground and the cables are to be completely removed. Here further impact on benthos and fish species composition will be created, because the structures and surfaces present during a period of some 40-50 years service life, disappear or change abruptly. Removal of the wind farm might allow commercial fishing to recommence in areas from which it had been excluded.

**First estimate of dimension:** The procedure of removing an offshore wind farm will cause similar disturbances as its installation (see above). After removing the turbines all possible disturbances for sea birds would be taken away too. However, removing the wind farm will open the area to renewed use for commercial fishery with all its impacts on fish stock and structure of the seabed.

**Measures decreasing the impact:** See section on “Environmental Impact During Installation of a Wind farm”. All sections of the turbines, piles, cables and anti-scour devices should be removed, through the application of techniques which minimise impacts on the surrounding environment, including the resuspension of sediment.

**Need for investigation:** The impact of removal operations and subsequent ecosystem changes which result should be subject to an appropriate monitoring programme.

#### 5.4 Conclusion and Recommended Practice for EIA

Though there is a considerable lack of knowledge about the various possible impacts associated with offshore wind energy developments it can clearly be concluded that setting up offshore wind farms will cause unfavourable environmental impacts, which cannot entirely be avoided by technical measures. Even though some of the described possible impacts may prove to be of no concern they may matter when carrying out an EIA at present. Quite a number of issues discussed above require basic scientific research on a large scale and over a period of several years (e.g. spatial and vertical distribution of bird migration across the North Sea; exact borders of important bird areas or sites under the Habitats Directive; important areas for whales, their sensitivity to noise); for further examples see sections above and [2], [23]. The environmental impact of a specific wind farm project can not fully be assessed without such basic knowledge.

From the findings stated above it can be concluded that some of the lacking knowledge however, may only be acquired from research work and ecological monitoring on the first full scale demonstration wind farm developments, such as those planned in Denmark (see section 1.4.1) and elsewhere.

A well organised and structured program to answer the pending questions could help to invoke a strategic and effective procedure to find designated areas for wind energy use prior to specific project developments. Because of the public interest and the extent and nature of the research needed this task cannot be left to the individual offshore project developers.

Therefore the EIA for offshore wind farms should have two separate stages:

##### Stage I

In the first stage, after a political decision about using offshore wind energy in the area of the North Sea is made, areas with the lowest ecological impact have to be identified and designated for offshore wind energy use. For example areas with only a small number of seabirds, fish and sea mammals, with ground heavy disturbed by fishery, with good conditions for grid connection, with small amounts of bird migration. This has to be done in a cooperative international effort with public participation (see [6], [22], [5]). A suitable level to do this could be a European program of investigation. A first review is presented in [23]. In particular the exclusion of SAC's and SPA's or possible SAC's and SPA's from possible sites may prevent delay and/or decline of actual wind farm developments.

In parallel to such a screening of potential sites the missing ecological and biological data (see above) should be collected. Before setting up new offshore wind farms, first experiences from the offshore wind farms in Denmark should be evaluated and investigations on unresolved questions should be intensified. Coordinated action is also necessary to ensure minimum negative impacts from electric power lines crossing conservation areas like the Wadden Sea. It could probably be acceptable to cross such an area in a few designated routes but it might not be if every single offshore wind farm was to have its own link.

## Stage II

In a second stage the individual impact of a specific wind farm project would have to be addressed and technical solutions to reduce or eliminate the remaining impacts should be identified.

According to the extensive EIA's in [5] and [6] a structure as given below seems to be suitable:

- Introduction
- Political preconditions
- Methods of investigation
- General alternative solutions
- Positive effects on the global environment (e.g. climate)
- Possible impairments to natural goods
  - Birds
  - Coast and sea floor
  - Water and plankton
  - Landscape
  - Fish
  - Benthos
- Archaeological sites
- Effects on economic and other factors
  - Fishery
  - Navigation
  - Gravel production
  - Defense
  - Recreation
  - Oil and gas production
- Effects from grid connection
- Economical and ecological efficiency

It should be part of an EIA to identify suitable compensation measures. Further information on the conceptual frame, extent and cost of site specific EIA can be found in [22].

## 5.5 References

- [1] Merck, T. & H. von Nordheim (in print): Nature conservation problems arising from the use of off-shore windenergy. German Journal of Hydrography Suppl. 10: 79-88 (in German with engl. Summary)
- [2] Kube, J. (2000): Programm für naturschutzrelevante Begleituntersuchungen an Offshore-Windenergieanlagen. Unveröff. Gutachten im Auftrage des Bundesamtes für Naturschutz und des Bundesministeriums für Umwelt, Naturschutz und Reaktorsicherheit, Vilm und Bonn
- [3] Mitsun, R.B. (1995, ed.): Underwater Noise of Research Vessels. ICES Cooperative Research Report No. 209, Copenhagen
- [4] Skov, H., J. Durinck, M. F. Leopold & M. Tasker (1995): Important Bird Areas for Seabirds in the North Sea. BirdLife International, Cambridge
- [5] Ministerie van Economische Zaken & Ministerie van Volkshuisvesting, Ruimtelijke Ordening en Milieubeheer (2000): Milieu-Effectrapport - Locatiekeuze Demonstratieproject Near Shore Windpark. Den Haag
- [6] ELSAMPROJEKT A/S (2000): Havmøller Horns Rev – Vurdering af Virkninger på Miljøet VVM-redegørelse. Notat EP00/001/JKG/HG, Fredericia
- [7] Europäische Kommission (2000): Natura 2000 - Gebietsmanagement. Die Vorgaben des Artikels 6 der Habitat-Richtlinie 92/43/EWG. Interpretationshilfe der Europäischen Kommission
- [8] Baltic cable: Strom im Verbund. Preussen Elektra, August 1997
- [9] Buurma, L.S. & H. Van Gasteren (1989): Trekvogels en obstacels langs de Zuidhollandse Kust. Koniuklyke Luchtmacht's Gravenhage
- [10] Hebert, E., E. Reese & L. Mark (1995): Avian collision and electrocution: an annotated bibliography, Report P700-95-0001. California Energie Commission.
- [11] Trapp, J. (1998): Bird kills at towers and other man-made structures: an annotated partial bibliography (1960-1998). Report, U.S. Fish and Wildlife Service, Virginia
- [12] Schonart, E. (1978): Ornithologische Beobachtungen während des Herbstzuges 1976 auf der Forschungsplattform "Nordsee". Orn. Mitt. 30: 29-33
- [13] Winkelman, J.E. (1992b): De invloed van de Sep-proefwindcentrale te Oosterbierum (Fr.) op vogels, 2: nachtelijke aanvaringskansen. RIN-dapport 92/3, DLO-Instituut voor Bos- en Natuurbeheer, Arnhem
- [14] Tucker, V.A. (1996): A mathematical model of bird collisions with wind turbine rotors. Journal of Solar Energy Engineering 118: 253-262
- [15] Tulp, I, H. Schekkerman, J.K. Larsen, J. Van der Winden, R.J.W. Van de Haterd, P. Van Horsen, S. Dirksen & A.L. Spaans (1999): Nocturnal flight activity of sea ducks near the windfarm Tunø Knob in the Kattegat. Bureau Waardenburg proj. nr. 98.100, report nr. 99.64, Utrecht
- [16] Dirksen, S., A.L. Spaans, J. Van der Winden & L.M.J. Van den Bergh (1996): Vogelhinder door windturbines. Landelijk onderzoekprogramma, deel 2: nachtelijke vlieg-hoogtemetingen van duikeenden in het IJsselmeergebied. Utrecht, 67 p.
- [17] Schreiber, M. (1993): Windkraftanlagen und Watvogelrastplätze - Störungen und Rastplatzwahl von Brachvogel und Goldregenpfeifer. Naturschutz und Landschaftsplanung 25, 4: 133 – 139
- [18] Schreiber, M. (2000): Windkraftanlagen als Störungsquellen für Gastvögel. Schriftenreihe des Bundesamtes für Naturschutz, im Druck
- [19] Spaans, A.L., J. van der Winden, L.M.J. van den Bergh & S. Dirksen (1995): Vogelhinder door windturbines. Landelijk onderzoekprogramma, deel 1: verkennend onderzoek naar nachtelijke vliegbewegingen in getiejdegebieden. Utrecht, 35 p. + Appendices
- [20] Winkelman, J.E. (1990): Verstoring van vogels door de Sepproefwindcentrale te Oosterbierum (Fr.) tijdens bouwfas en half-operationele situaties (1984-1989) RIN-rapport 90/9: 157 p.; Rijksinstituut voor Natuurbeheer. Arnhem

- [21] Guillemette, M., J.K. Larsen & I. Clausager (1998): Impact assessment of an offshore wind park on sea ducks. NERI Technical Report 227. National Environmental Research Institute, Kalø
- [22] Grastrup, H., J.K. Gaarde, J.M. Svenson & P.H. Pedersen (1997): Environmental impact assessment of the first four offshore wind farms in Denmark. 417 - 427
- [23] Oranjewoud (2000): Pilot study: offshore wind farm locations in the North Sea (draft version, 3.8.2000). Heerenveen
- [24] SC-DLO (1999): Methode en data voor het voorspellen van zichteffecten. In: Milieu-Effectrapport locatikeuze Demonstratieproject Near Shore Windpark. Ministerie van Economische Zaken & Ministerie van Volkshuisvesting, Ruimtelijke Ordening en Milieubeheer, Den Haag (2000)
- [25] Franeker, J. A. Van (1998): Nam ENSCO71 Flaring Project – Project ter voorkoming van vogel-incidenten bij het affakkelen van gas vanaf het platform ENSCO71 voor de Zuid-Hollandse kust in de periode 28 september – 3 oktober 1998. Nederlandse Aardolie Maatschappij BV (NAM), Wageningen
- [26] Clemens, T. (1978): Vergleichende Untersuchungen des Nachtvogelzuges auf Helgoland im März 1976 und 1977 nach Radar- und Feldbeobachtungen. Diplomarbeit, Oldenburg
- [27] Tasker, M.L., P.H. Jones, B.F. Blake, T.J. Dixon & A.W. Wallis (1986): Seabirds associated to oil production platforms in the North Sea. Ringing & Migration 7: 7 -14
- [28] Frid, C.L.J. & R.A. Clark (2000): Long-term changes in North Sea benthos: discerning the role of fisheries. In: The Effect of Fishing on Non-target Species and Habitats.
- [29] Garthe, S., K. Alicki, O. Hüppop & B. Sprotte (1995): Die Verbreitung und Häufigkeit ausgewählter See- und Küstenvogelarten während der Brutzeit in der südöstlichen Nordsee. Jour. Ornithol. 136: 253 – 266
- [30] Camphuysen, C.J. (1996): De Verspreiding van Zeevogels in de Noordzee: Naar een beter Begrip van Patronen en Verbanden. Sula 10 (Spezial issue 2): 41- 88
- [31] Lensink, R. & J. Van der Winden (1997): Trek van niet-zeevogels langs en over de Noordzee: een verkenning. Culemborg, 59 p.
- [32] Larsson, A.-K. (1994): The environmental impact from an offshore plant. OWEMES '94
- [33] Wolf, R. (1998): Der Schutz der Umwelt beim Bau von Bohrinnseln. Umweltplanungsrecht (UPR) 1998/8: 281 – 289
- [34] ELKRAFT v/ SEAS Wind Power Department, ELSAM Production, The Danish Energy Agency & The National Forest and Nature Agency (1997): Action Plan for Offshore Wind Farms in Danish Waters.
- [35] Garthe, S. (1993): Quantifizierung von Abfall und Beifang der Fischerei in der südöstlichen Nordsee und deren Nutzung durch Seevögel. Hamb. Avifaun. Beitr. 1993: 125 – 237

## 6. Socio-Economic Effects

In order to give an impression of the socio-economic effects to be expected from the exploitation of offshore wind energy, the following section highlights the effect that the expected development in Germany will have on job creation. The effect is roughly quantified with no attempt to have it further detailed. To give a complete picture not only of gross estimates on the number of jobs created but also on the qualifications needed is certainly out of the scope of this study.

Based on the development of the installed power of wind turbines (WT), presented in chapter 1.1.1, the total investment in wind energy use in Germany can be calculated. The development of the total investment in wind energy use in Germany between 1990 and 1999 is presented in fig. 6.1. This calculation assumes a decrease of the specific investment per installed kW shown in fig. 6.2. In 1990 the average of the specific investment per installed kW amounted to about 1,400 Euro. This value decreased to 1,120 Euro/kW in 1999. Total investment in wind energy use in Germany based on the values of the specific investment in 1990 amounted to 51 million Euro. By 1998 the total investment increased to 892 million Euro. In 1999 there was a doubling of that development in Germany. 1,760 million Euro were invested in wind energy in 1999 alone. The majority of the total investment was placed in the economically weak areas of northern Germany.

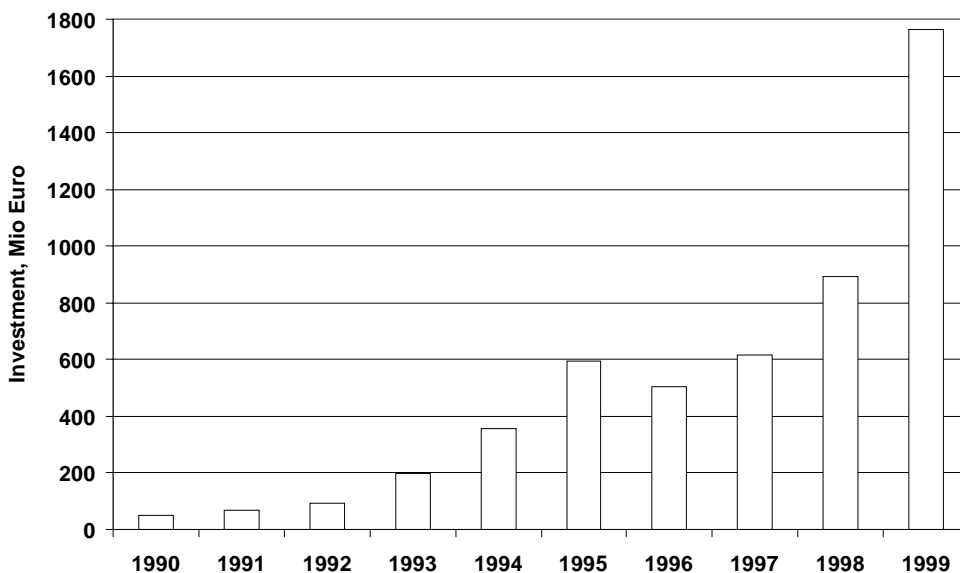

Fig. 6.1: Development of the total investment in wind energy use in Germany.

The presentation in fig. 6.2 of the specific total investment per kW does not consider the rate of inflation. Therefore the real decrease of specific investment per kW is substantially higher. In [1] a decrease of the specific cost of WT of 50 % between 1990 and 1998 considering the rate of inflation could be shown.

The efficiency of production and installation of WT has improved extraordinarily over the past 10 years. Between 1990 and 1995 the manpower employed by WT manufacturers was reduced from 12 to 4 per MW [2]. Nevertheless there was a strong increase in the number of employees in the industrial sector of wind energy on account of the equally strong increase in the installed wind power per year over the past 10 years. Generally a distinction has to be made between direct and indirect employees. The employees of the industrial sector of wind energy such as employees of turbine and component manufacturers, employees of wind project promoters and companies which are operating wind farms are considered as direct employees. Employees of other industrial sectors which are economically based on the industrial sector of wind energy are referred to as indirect employees.

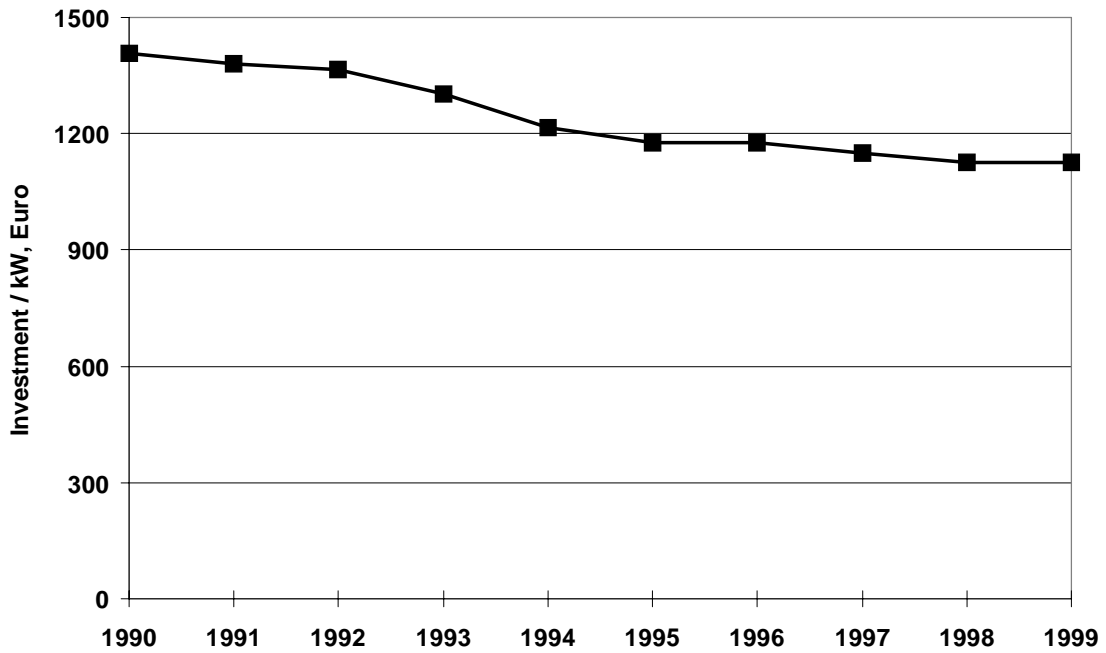

Fig. 6.2: Development of the average investment for wind energy projects in Germany related to the installed power .

In fig. 6.3 the development of the number of persons employed based on the industrial sector of wind energy is presented.

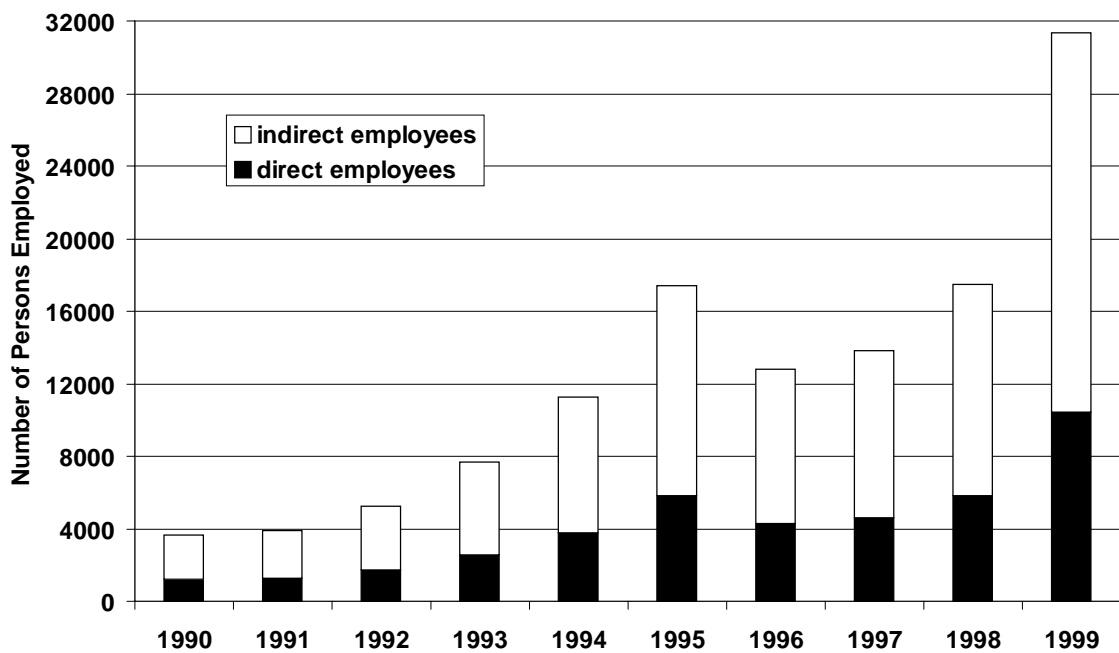

Fig 6.3: Development of the number of persons employed based on wind energy use in Germany.

Statistics of the industrial sector of mechanical engineering give a ratio of 1 to 2 for direct employees relative to indirect employees. That means two jobs in indirect employment will be created by just one direct job in the wind energy industry.

The calculation of the number of persons employed is based on the turnover per direct employee. In the sector of mechanical engineering this value amounts to between 150,000 and 180,000 Euro/employee in Germany. In the past the turnover per employee in the field of wind energy use was considerably smaller. But the efficiency of production and installation of WT grew rapidly and therefore the value of the turnover per employee can be assumed to be of the same size as in the industrial sector of mechanical engineering. This calculation leads to 31,350 persons employed based on the turnover in Germany in 1999 (see fig. 6.3). Most of these jobs have been created in Germany because many components also of Danish wind turbines such as



gearboxes, generators and towers are produced in Germany. With regard to offshore wind energy the investment per MW is assumed to increase by some 60 % relative to the onshore projects. Equally the costs for operation and maintenance are estimated to be fundamentally higher compared to the onshore situation. These higher costs obviously lead to more manpower needed per installed MW using offshore wind energy. Therefore it may be assumed that offshore wind energy use with the national targets as described in chapter 1.4 will lead to a strong increase in the absolute number of employees in this sector.

Calculation of the number of employees depends on the national conditions in the respective country. Labour costs, for example, vary, and therefore the turnover per employee also varies for different countries.

## **6.1 References**

[1] Schwenk, B.; Rehfeldt, K.: Studie zur Kostensituation der Windenergienutzung in Deutschland. Herausg. Bundesverband Windenergie e.V., Osnabrück 1999.

[2] Keuper, A.: Umsatz und Beschäftigung durch den deutschen Windenergiemarkt. DEWI-Magazin Nr. 6 (Februar 1995) S. 28-30.

## 7. Conclusions

In the light of climate protection and resource conservation the extended use of wind energy on- and offshore in truly sustainable energy policies has been shown to be indispensable. Only if the momentum in the development of wind energy use in Europe is maintained will the CO<sub>2</sub> reduction targets in the Kyoto Protocol may be obtained with considerable contributions from wind energy. As onshore sites become more and more scarce, offshore wind energy will need to be phased in within the next 5 years.

The revised information gives evidence on the vast wind energy potential of the North Sea waiting to be exploited. Depending on the applied natural and man made or political constraints that are applied, a large portion of Europe's electricity demand could be covered by offshore wind energy.

Offshore wind energy technology is a new technology created by the merging of classical wind energy technology and classical offshore technology. Although fairly young, a number of feasibility studies and experiences from first smaller demonstration projects in the Baltic give rise to aspirations of successful large scale applications in the North Sea. A number of design solutions for the implementation of suitable and efficient wind turbines, grid connection technologies and wind farm lay-outs are at hand waiting to be applied in first stage demonstration projects.

Economic considerations carried out in this study imply that sites at even large distances to shore of several tens of kilometers may economically be developed depending on the characteristics of the coastal shelf considered.

With respect to environmental issues it has been found that there is a considerable lack of knowledge about the various possible impacts associated with offshore wind energy developments. However, it can be concluded that offshore wind farms will cause unfavourable environmental impacts, which cannot entirely be avoided by technical measures. Some of the missing knowledge in this respect will only be acquired from research work and ecological monitoring on the first, full-scale, demonstration wind farm developments.

A strategic and effective procedure to find designated areas for wind energy use prior to specific project developments is needed and must include coordinated planning of grid connection solutions on the European scale.

On the whole, offshore wind energy represents an energy option that should not be disregarded in the context of a future sustainable energy supply.